

### GYMNASTICS AREA 14x14M & 13x13M «MONTRÉAL» EVOLUTION COMPETITION & TRAINING SPRINGS EXERCISE FLOOR WITH ROLL-UP TRACKS M'20

**6776/00 - 6778/00**  
**6776C - 6776C/DE**  
**6778C - 6778C/DE**

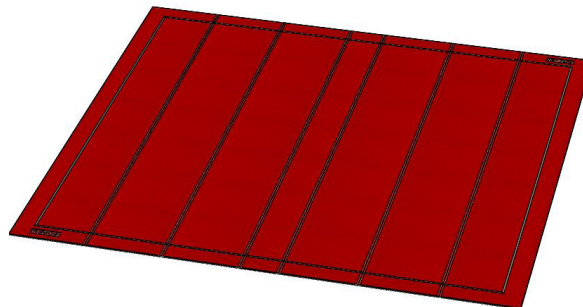

6776C & 6776C/DE

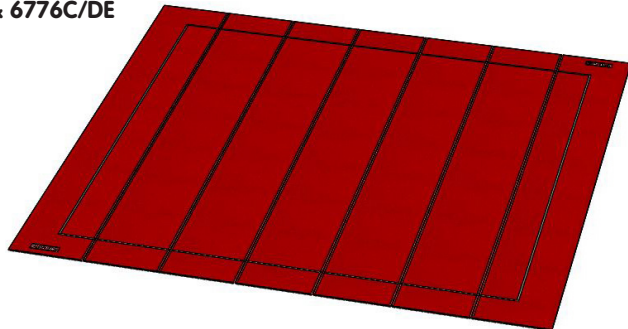

**KEEP THIS DOCUMENT**

#### Warning:

This equipment should be installed by a qualified individual. This equipment should only be used by one person at a time, under the supervision of a qualified individual.

Using this equipment for purposes other than those originally intended is prohibited.

#### Compliance:

14 x 14 m Exercise floors ref. 6776C and 6776C/DE are FIG approved.

#### Recommendations:

- keep these instructions for subsequent reference (inspection, maintenance, etc.).
- periodically carry out predictive maintenance.
- depending on how much it is used have the equipment serviced yearly or every few years.

#### Pack list:

COLIS REF.	6776/01 14 x 2 m roll-up track, th. 38mm	6776/02 14 x 1 m roll-up track, th. 38mm	6574/20 Rule, length 2 m for cutting	6579/15 Spring exercise floors accessories	Number of packages
6776/00 14 x 14 m gymnastics area th: 38mm	7	-	1	1	9
6778/00 13 x 13 m gymnastics area th: 38mm	6	1	1	1	9
<b>VOLUME (M<sup>3</sup>)</b>	1.57	0.79	0.004	0.05	X
<b>WEIGHT (KG)</b>	61	31	2	6.3	
<b>SIZE (MM)</b>	2000 x Ø1000	1000 x Ø1000	2000 x 100 x 20	500 x 350 x 300	

#### I. Maintenance:



##### IMPORTANT :

**Leave the roll-up tracks to rest for at least 48 h.** The gymnastics area overlaps the floor: cut off any necessary excess tracks Repeat the process if necessary (tracks dimensions vary over time).

- Regular cleaning of the exercise floor makes it easier to spot any problems (distortion, breakage or moisture absorption).
- Check the condition of the roll-up tracks **(1)** and **(2)**, and the anti-rotation kit **(3)+(4)**.
- Check the condition of the floor (wood panels, springs, plastic parts, sections and plates - **NM273A or NM274A**) and of the Foam underlay **(NM285)**.
- Any damaged or distorted component should be replaced as quickly as possible.

#### II. Disassembly and storage of roll-up tracks:

Carefully roll up the joining strips **(5)**, then fold the 7 tracks **(1)**, or **(1)** and **(2)**. Store the tracks rolls flat in a clean, dry location. Do not store any heavy, protruding or other item on top. Avoid direct contact with the floor.

### III. Assembling the gymnastics area: (👤👤 minimum).

- 14x14m th. : 3.8cm with roll-up tracks (Ref.: 6776/00). Set of 4 finishing bibs 14m (Ref.: 6575/10).
- 13x13m th. : 3.8cm with roll-up tracks (Ref.: 6778/00). Set of 4 finishing bibs 13m (Ref.: 6577/00).

**Figures 1 - Installing the Anti-Rotation Kit of the gymnastics area**

Glue the 8 two-by-two beige adhesive self-gripping strips of 200 x 5cm (3) on each side of the foam underlay. Cover them with the 4 strips of 150 x 25 cm black textile adhesive (4)

**Important:** wait the end of step III, to remove the protective film from the 4 strips (4)

14 x 14m underlay foam

13 x 13m underlay foam

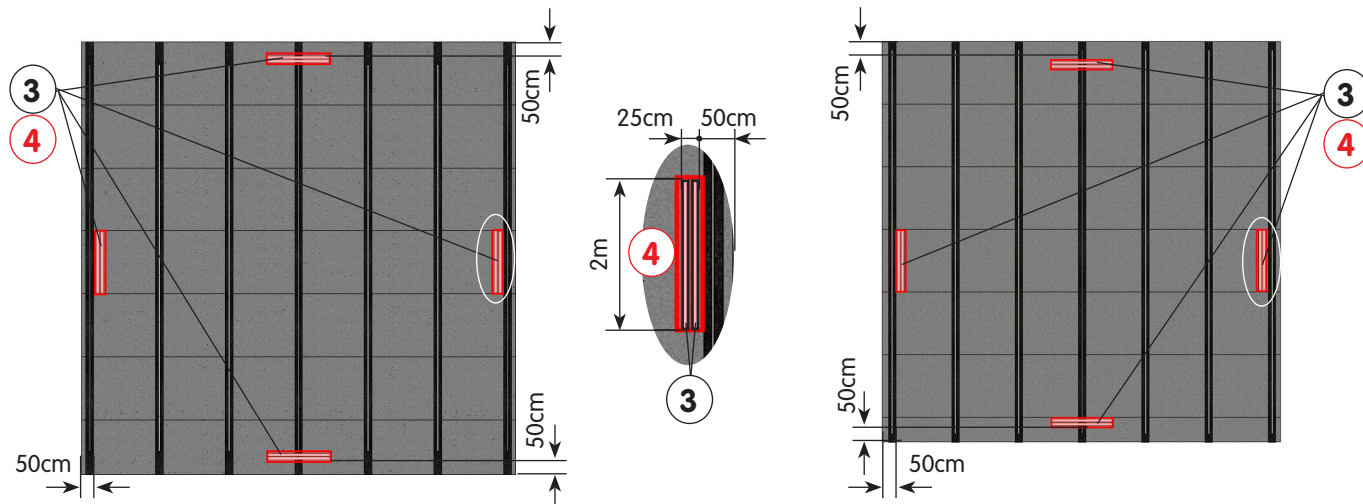

**Figures 2 - Installing the gymnastics area**

Unroll roll-up tracks (1), or (1) and (2) from area foam strips layout

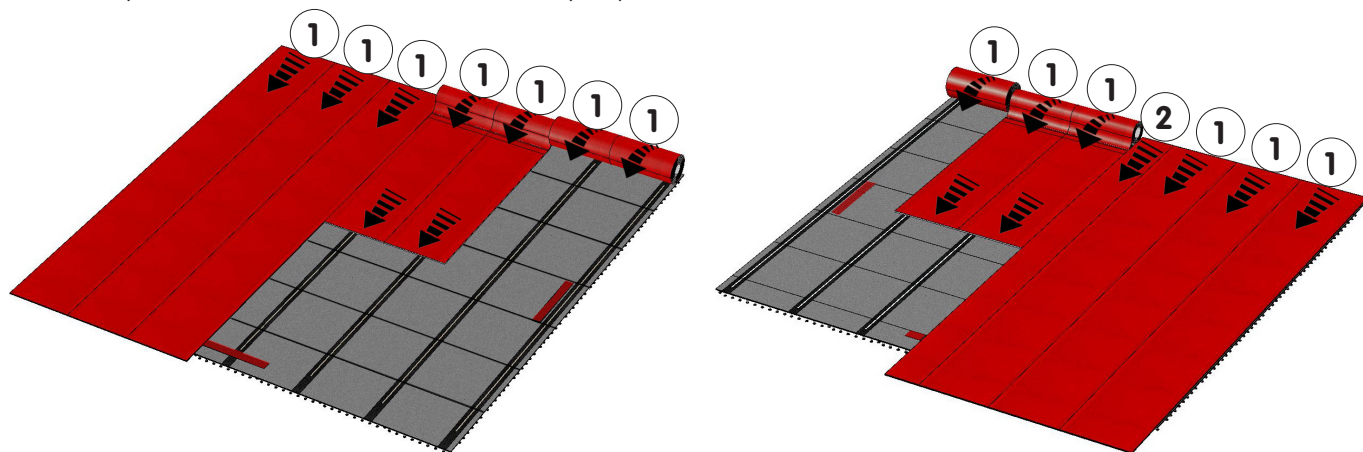

**Figures 3 - Binding the gymnastics area**

Align these roll-up tracks (1), or (1) and (2) with an **angle of the floor**. Bonding by 6 red self-gripping strips (5) (length 14m - width 10cm) straddling each track.

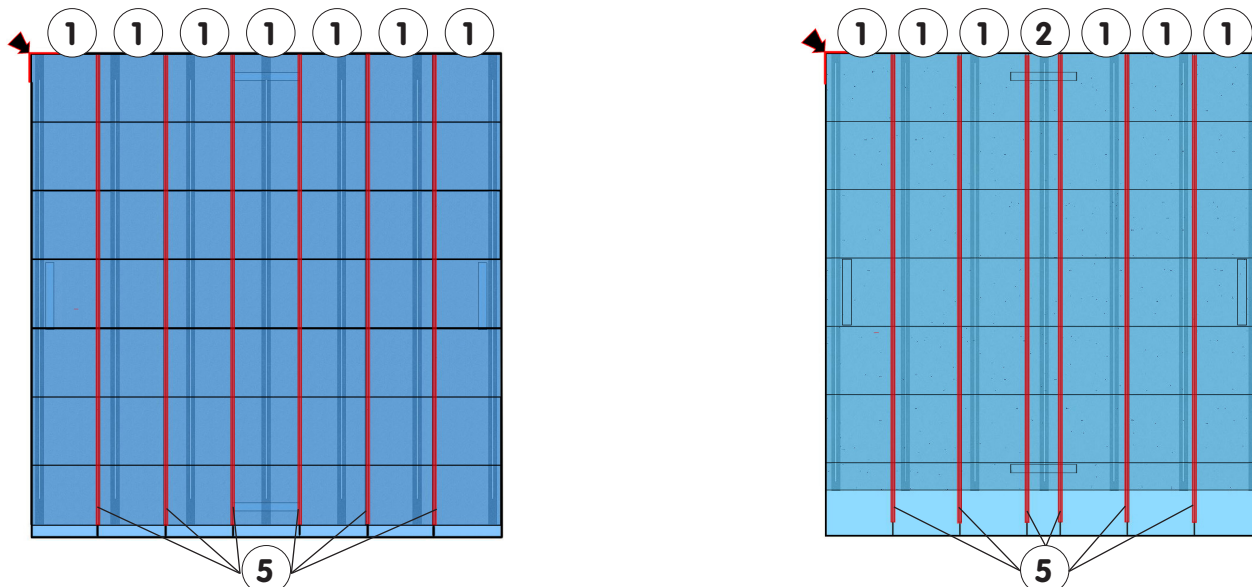

**Figures 4 - Cutting the gymnastics area**

**Cut the protruding part** of the extremity of the roll-up tracks (1), or (1) and (2) from the floor edge.

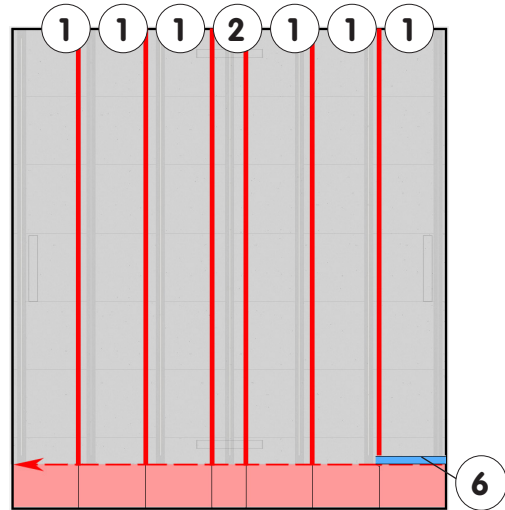
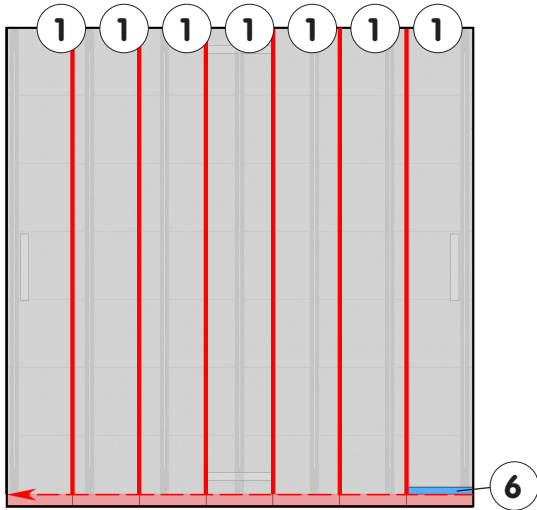
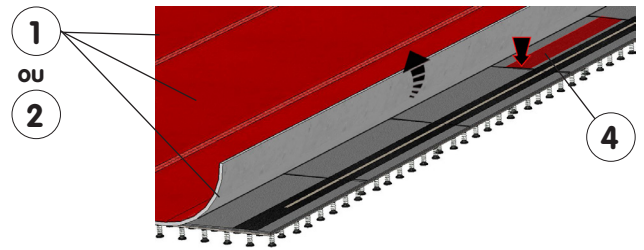
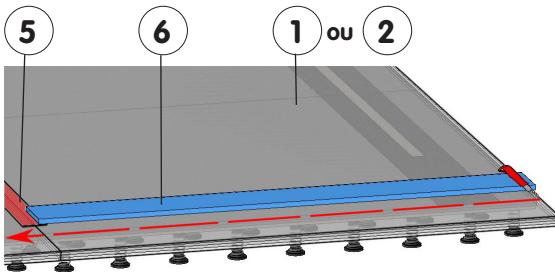

**Figure 5 - Cutting the gymnastics area detail**

**Cut** the protruding part using the 2m (6) ruler (supplied) and a cutter, along the wooden floor plates.

**Figure 6 - Gymnastics area ARK activation**

Lift the roll-up tracks (1), or (1) and (2) on the 4 sides of the floor, then remove the protective film from the 4 adhesive black textile strips (4).



**Figures 7 - Gymnastics area markings**

Place the 4 beige self-gripping strips (7) 5cm wide to define the 12 x 12m area of evolution.

**Note:** the strips are placed inside the zone. Position the 2 Gymnova markings (8) outside the zone of evolution.

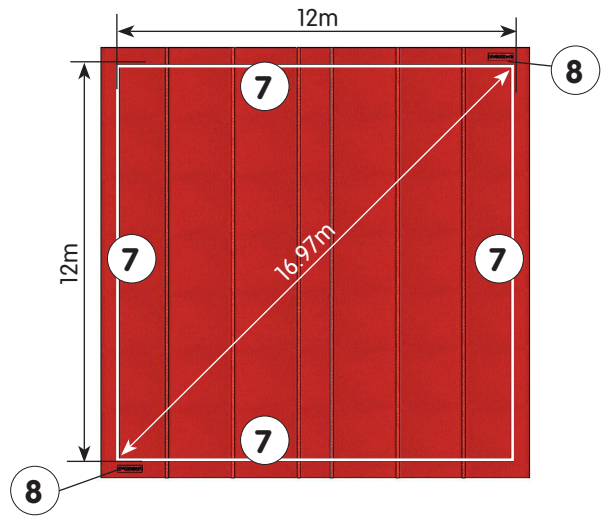
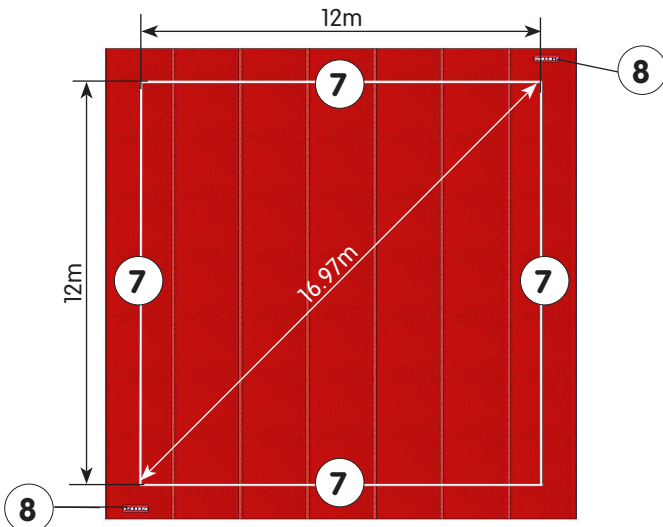

**Figures 8 - Fitting of the exercise floor finishing bibs**

Align the end (male self-gripping side) of one bib (9) or (9') on one corner of the exercise floor. Stretch and flatten on the first side of the exercise floor, plus angle feedback. Bind the second bib to the female hook-and-loop of the first and repeat the operation for the next 2.

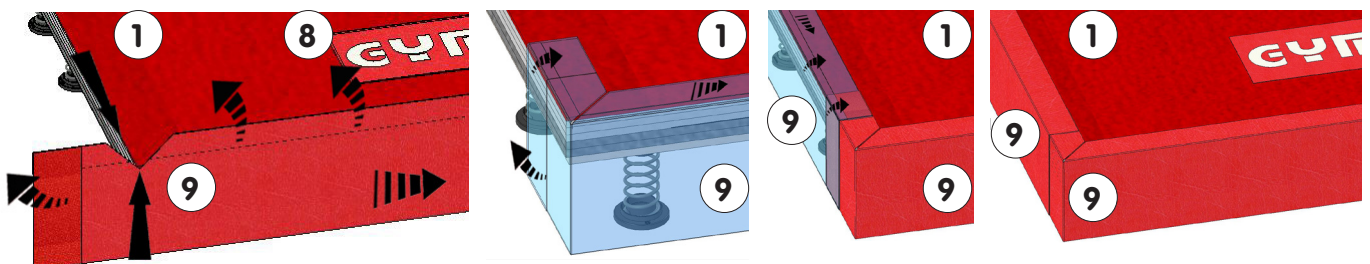

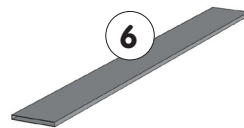
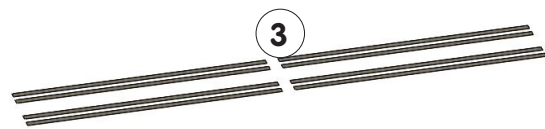
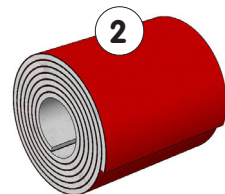
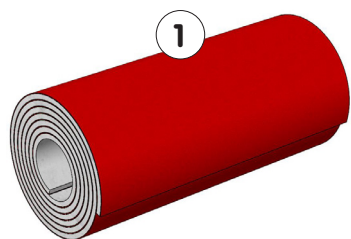
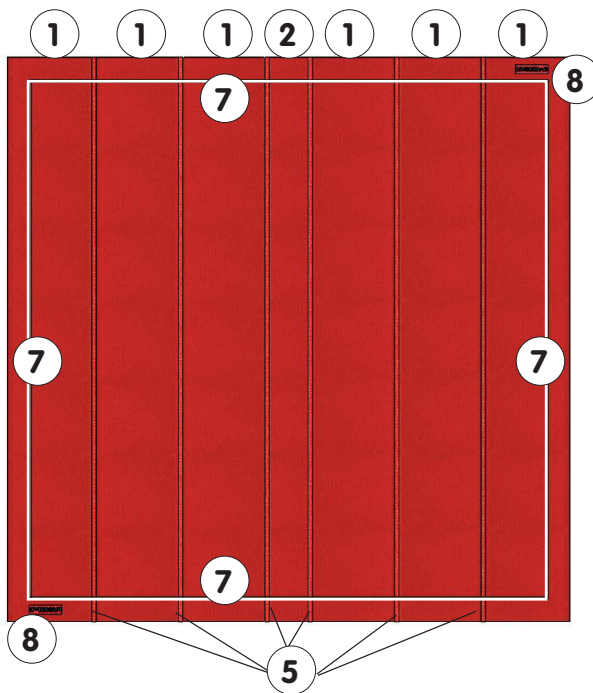
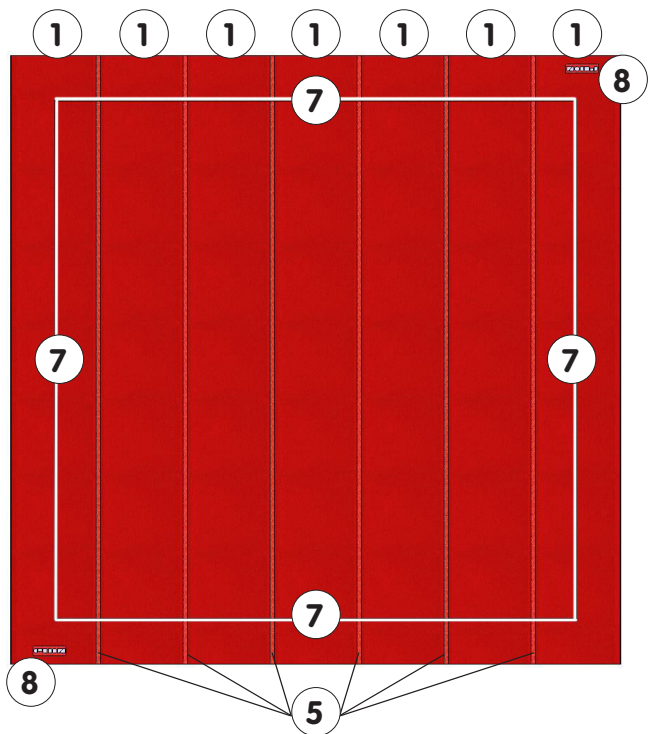

29	-	-	-	-
28	-	-	-	-
27	-	-	-	-
26	-	-	-	-
25	-	-	-	-
24	-	-	-	-
23	-	-	-	-
22	-	-	-	-
21	-	-	-	-
20	-	-	-	-
19	-	-	-	-
18	-	-	-	-
17	-	-	-	-
16	-	-	-	-
15	-	-	-	-
14	-	-	-	-
13	-	-	-	-
12	-	-	-	-
11	-	-	-	-
10	-	-	-	-
9'	4	Finishing bib of 13m	6577/01	6778C
9	4	Finishing bib of 14m	6575/11	6776C
8	2	Gymnova marking pad	6574/11	6776C - 6778C
7	4	Beige hook-and-loop strip 12mx5cm	-	6776C - 6778C
6	1	2m Ruler for cutting roll-up tracks.	6574/20	6776C - 6778C
5	6	Red male bonding strip 14.2mx10cm	6574/15	6776C - 6778C
4	4	Black adhesive textile pad 2mx25cm	-	6776C - 6778C
3	8	Beige hook-and-loop strip 2mx5cm	-	6776C - 6778C
2	1	Roll-up track 14x1m th.38mm	6776/02	6778C
1	7-6	Roll-up track 14x2m th.38mm	6776/01	6776C - 6778C
REP	NBR	DESIGNATION	REFERENCE	OBSERVATION

**GYMNASICS AREA 14x14M & 13x13M  
«MONTREAL» EVOLUTION COMPETITION & TRAINING SPRINGS  
EXERCISE FLOOR WITH ROLL-UP TRACKS M'20**

To order spare parts, please provide the description, reference and delivery date of the entire apparatus.

Constantly aiming to improve our products, we reserve the right to make changes to the equipment and dimensions without further discussion.

This document is the property of Gymnova, it is confidential and shall not be reproduced.

### FOAM UNDERLAY 14x14M «MONTRÉAL» EVOLUTION COMPETITION & TRAINING SPRINGS EXERCISE FLOOR WITH ROLL-UP TRACKS M'20

**6776/10**  
**6776C - 6776C/DE**  
**6778C - 6778C/DE**



6776C & 6776C/DE

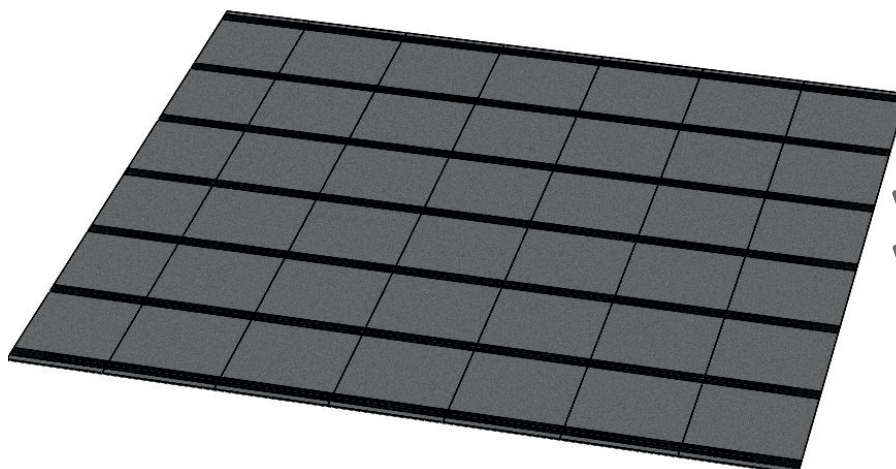

**KEEP THIS DOCUMENT**

#### Warning:

This equipment should be installed by a qualified individual. This equipment should only be used by one person at a time, under the supervision of a qualified individual.

Using this equipment for purposes other than those originally intended is prohibited.

#### Compliance:

14 x 14 m Exercise floors ref. 6776C and 6776C/DE are FIG approved.

#### Recommendations:

- keep these instructions for subsequent reference (inspection, maintenance, etc.).
- periodically carry out predictive maintenance.
- depending on how much it is used have the equipment serviced yearly or every few years.

#### Pack list:

PACK REF.	6542/00 7 joining strips for foam tracks	6586/10 Foam area ARK M13	6776/11 Foam roll 14 x 2.04m th. 24mm	6776/12 Set of 7 textile adhesive strips 14m	Number of packages
6776/10 Foam area 14x14m th: 24mm	1	1	7	1	10
VOLUME (M <sup>3</sup> )	0.02	0.01	1.01	0.06	X
WEIGHT (KG)	2.1	1.1	21	8.5	
SIZE (MM)	360 x 260 x 180	310 x 210 x 190	2060 x 700 x 700	1000 x 300 x 200	

#### I. Maintenance :



##### IMPORTANT:

**Leave the foam to rest for at least 48 h.** The foam area overlaps the floor: cut off any necessary excess foam. Repeat the process if necessary (foam dimensions vary over time).

- Regular cleaning of the exercise floor makes it easier to spot any problems (distortion, breakage or moisture absorption).
- Check the condition of the foam rolls **(1)** and the anti-rotation kit **(2)**.
- Check the condition of the floor (wood panels, springs, plastic parts, sections and plates - **NM273A** or **NM274A**) of the gymnastics area with tracks **(NM286)**.
- Any damaged or distorted component should be replaced as quickly as possible.

#### II. Disassembly and storage of the foam:

Carefully roll up the joining strips **(5)**, then fold the 7 foam tracks **(1)**. Store the stacked foam tracks flat in a clean, dry location. Do not store any heavy, protruding or other item on top. Avoid direct contact with the floor.

### III. Assembling the underlay impact-absorbing foam area (6776/10) (👤👤 minimum).

**Figures 1 - Installing the Anti-Rotation Kit of the foam area**

Place each of the 4 strips of 150 x 25 cm black textile adhesive (2) on each self-gripping pad on the floor corners.

**Important:** wait the end of step II, to remove the protective film from the 4 strips (2)

**14 x 14m Floor**

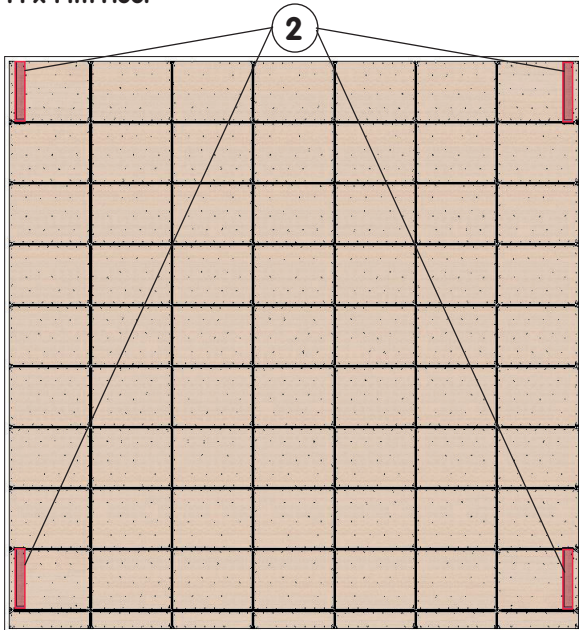

**13 x 13m Floor**

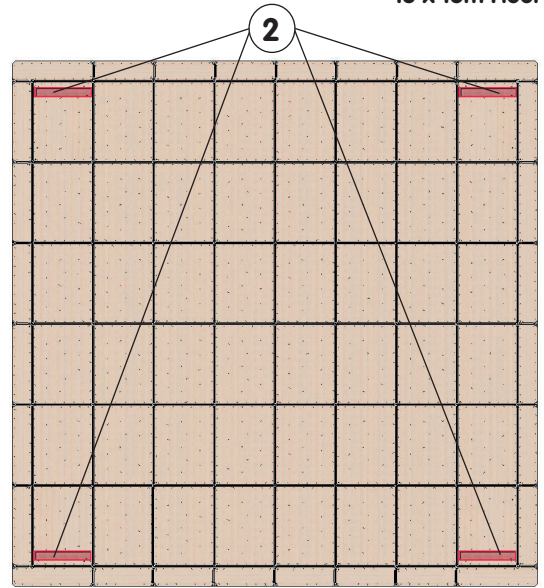

**Figures 2 - Installing the foam area**

Unroll foam rolls (1) from wooden floor plates layout

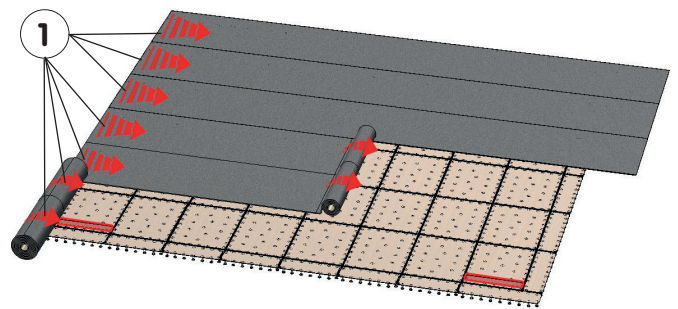
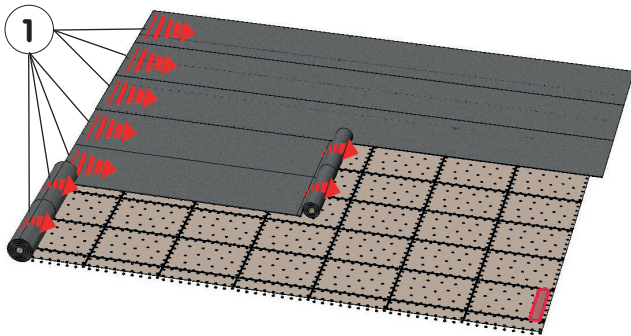

**Figures 3 - Binding the foam area**

Align these foam strips (1) with an **angle of the floor**. Bonding by 7 adhesive black textile strips (3) (length 14m - width 25cm)

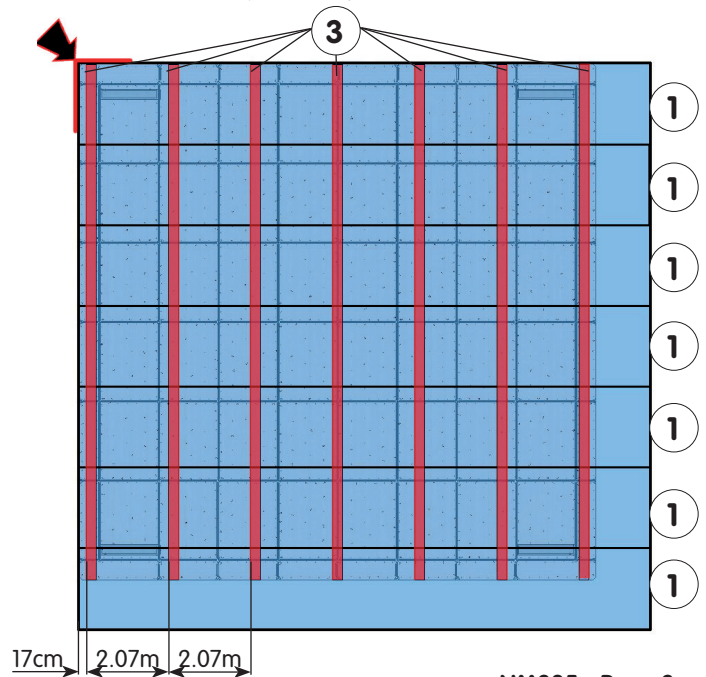
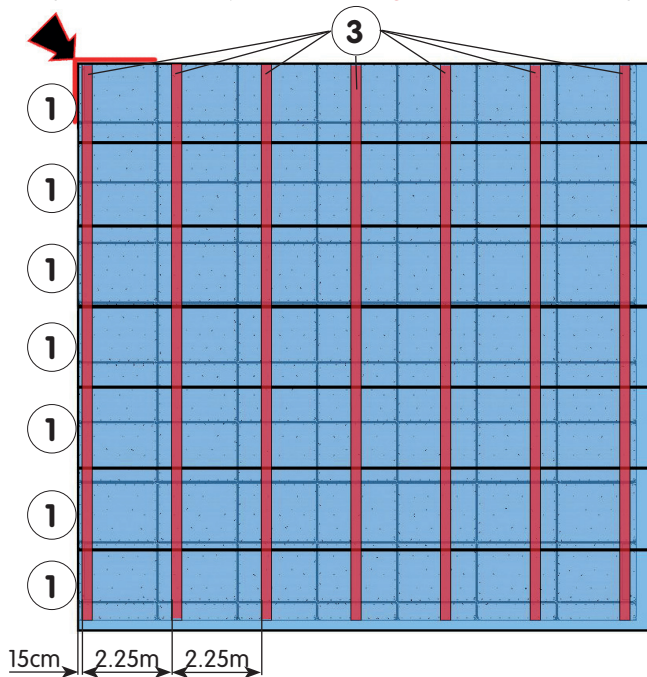

**Figures 4 - Cutting the foam area**

**Cut** the protruding part of the foam strips (1) from both sides of the floor edge.

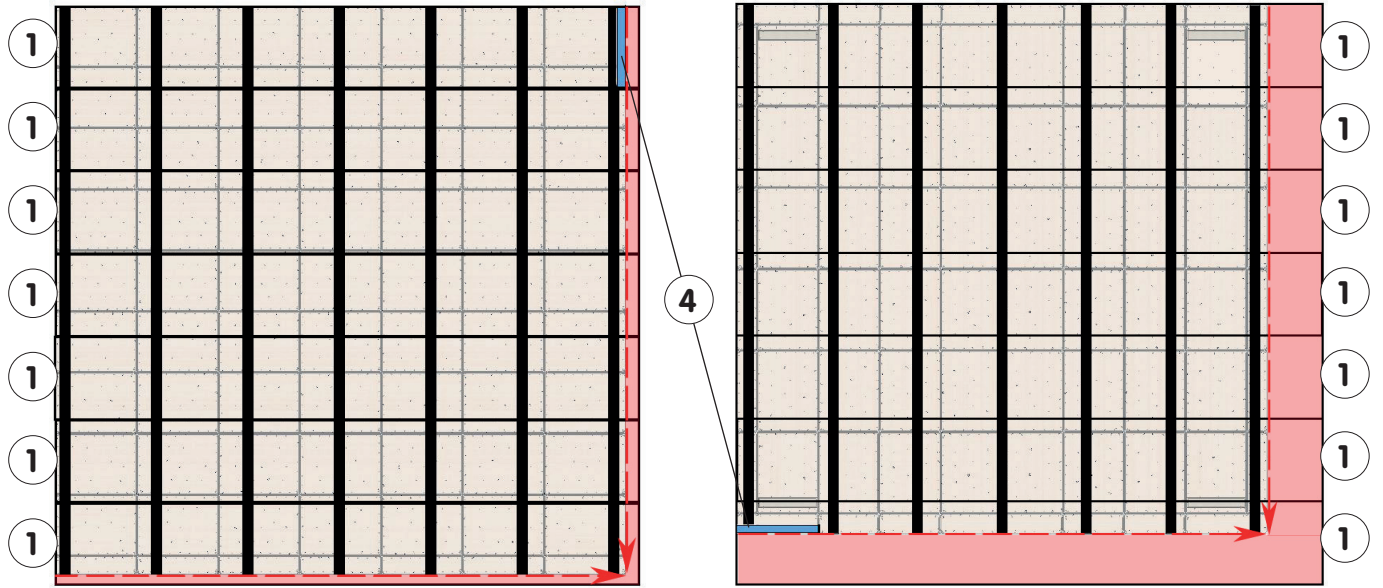

**Figure 5 - Cutting the foam area detail**

**Cut** the protruding part using the 2m (4) ruler (supplied with the roll-up tracks) and a cutter, along the wooden floor plates.

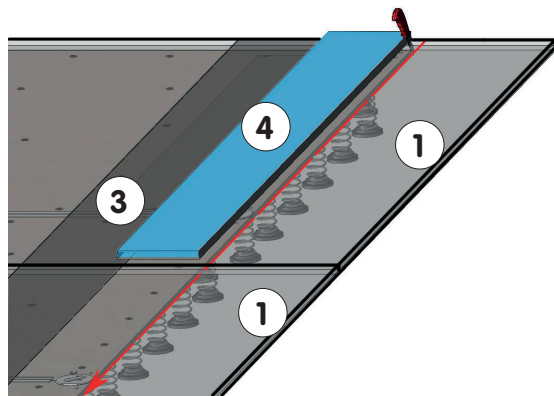

**Figure 6 - Area foam ARK activation**

Lift the foam strips (1) at the 4 corners of the floor, then remove the protective film from the 4 adhesive black textile strips (2).

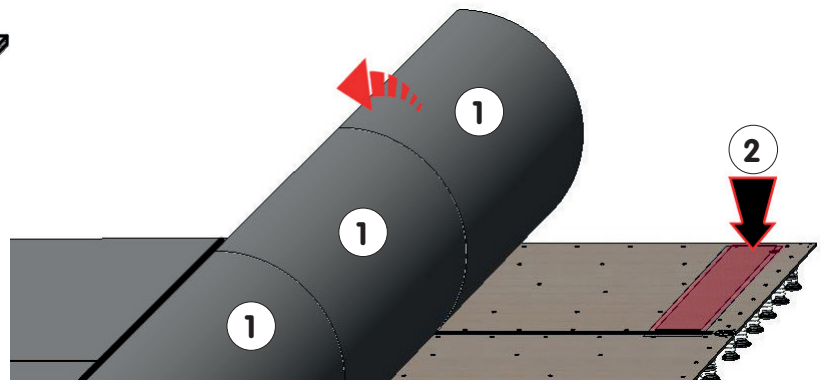

**Figures 7 - Foam area disassembly option**

**Cut** the 7 black adhesive textile strips (3) between the foam strips (1) to separate them. Bind them thanks to 7 beige hook-and-loop strips (5) (5cm width - Length 12,50m)

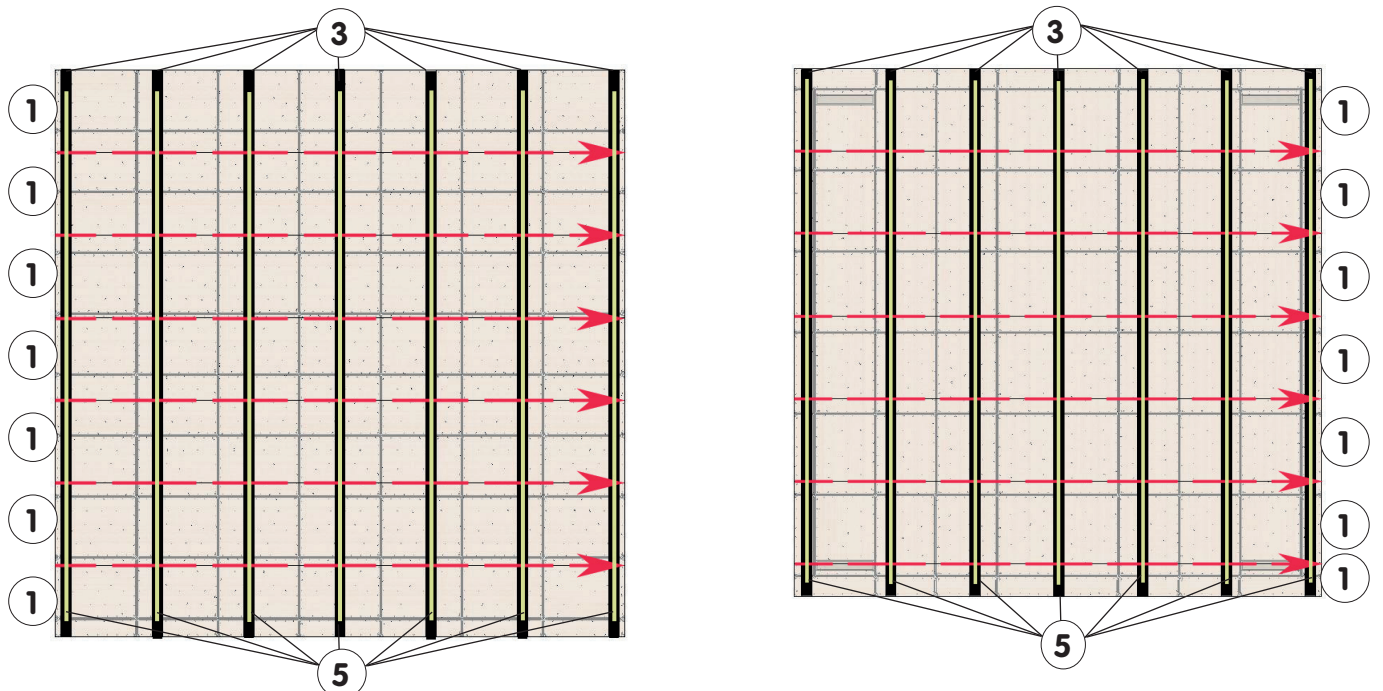

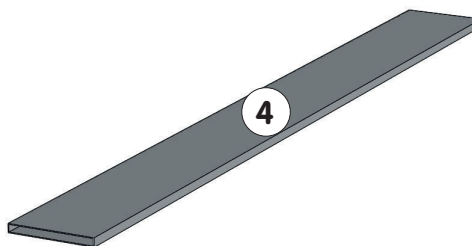
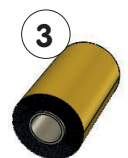
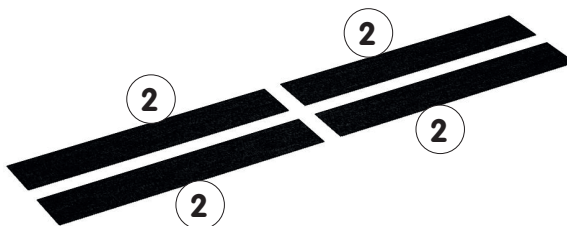
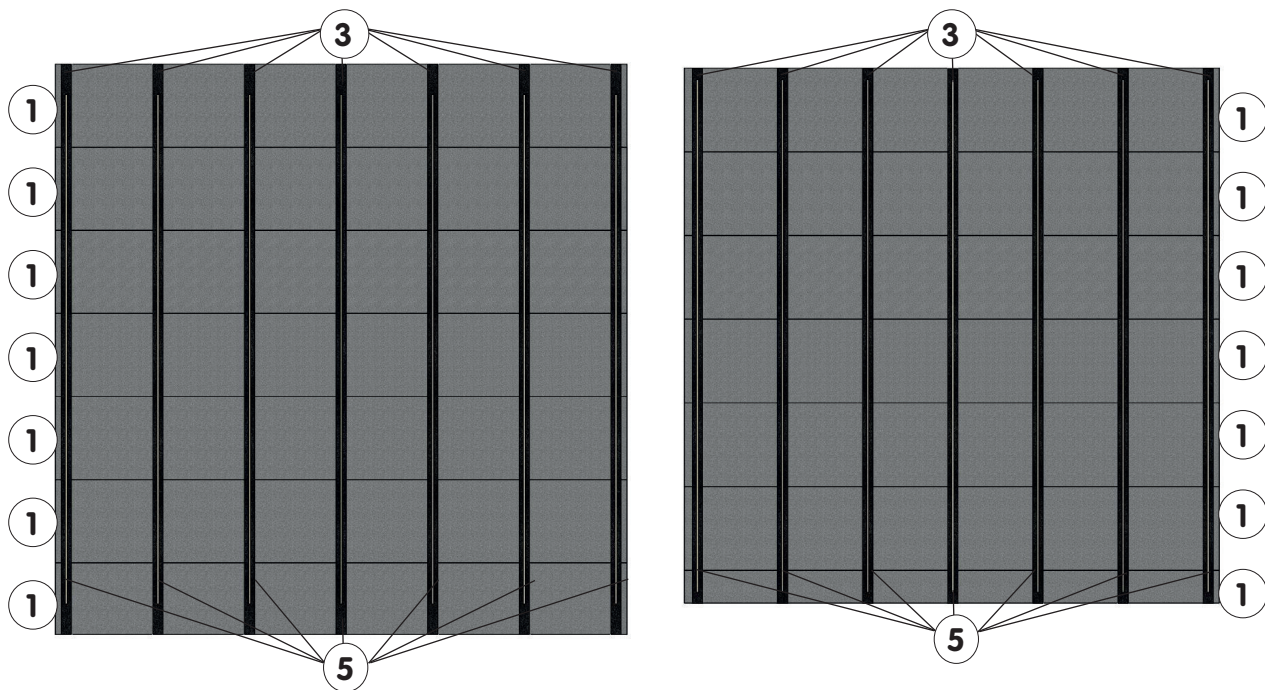

30	-	-	-	-
29	-	-	-	-
28	-	-	-	-
27	-	-	-	-
26	-	-	-	-
25	-	-	-	-
24	-	-	-	-
23	-	-	-	-
22	-	-	-	-
21	-	-	-	-
20	-	-	-	-
19	-	-	-	-
18	-	-	-	-
17	-	-	-	-
16	-	-	-	-
15	-	-	-	-
14	-	-	-	-
13	-	-	-	-
12	-	-	-	-
11	-	-	-	-
10	-	-	-	-
9	-	-	-	-
8	-	-	-	-
7	-	-	-	-
6	-	-	-	-
5	7	Beige hook-and-loop strip 5cmx12.5m	-	Inclu. in 6542/00
4	-	2m Ruler for cutting roll-up tracks.	6574/20	NM286 (6776/00)
3	7	Black adhesive textile strip 14mx25cm	-	Inclu. in 6776/12
2	4	Black adhesive textile pad 150x25cm	-	Inclu. in 6586/10
1	7	Roll-up foam 14x2m th.24mm	6776/11	6776C - 6778C
ITEM	QTY	DESCRIPTION	REFERENCE	REMARKS

**FOAM UNDERLAY 14x14M**  
**«MONTRÉAL» EVOLUTION COMPETITION & TRAINING SPRINGS**  
**EXERCISE FLOOR WITH ROLL-UP TRACKS M'20**

To order spare parts, please provide the description, reference and delivery date of the entire apparatus.

Constantly aiming to improve our products, we reserve the right to make changes to the equipment and dimensions without further discussion.

This document is the property of Gymnova, it is confidential and shall not be reproduced.





### 14 x 14M THICKNESS 14CM SPRUNG FLOORS WITH MOUNTED & NOT MOUNTED SPRINGS «MONTREAL» EVOLUTION COMPETITION EXERCISE FLOOR M'20

**6785A - 6787A**  
**6775D - 6775D/DE**  
**6776C - 6776C/DE**



**6775D & 6775D/DE**  
**6776C & 6776C/DE**

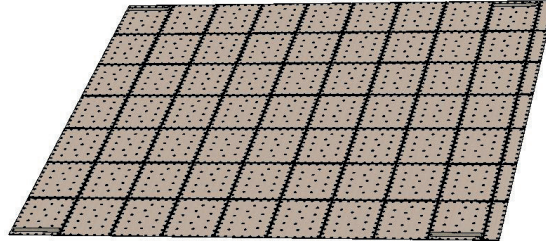

**KEEP THIS DOCUMENT**

### Warning:

This equipment should be installed by a qualified individual. This equipment should only be used by one person at a time, under the supervision of a qualified individual.

Using this equipment for purposes other than those originally intended is prohibited.

### Compliance:

14 x 14 m Exercise floors references **6775D - 6775D/DE et 6776C - 6776C/DE** are FIG approved.

### Recommendations:

- Keep these instructions for subsequent reference (inspection, maintenance, etc.).
- Periodically carry out predictive maintenance.
- Depending on how much it is used have the equipment serviced yearly or every few years.

### Maintenance:

#### IMPORTANT :

- Regular cleaning of the exercise floor makes it easier to spot any problems (distortion, breakage or moisture absorption).
- Check on the presence and condition: of the profiles **(8), (9), (10), (11) & (12)** and linking plates **(13) & (14)** properly locked.
- Check the condition of the floor: wood panels **(4), (5), (6) & (7)**, springs **(2)** and plastic parts **(1) & (3)**,
- Check the condition of the floor anti-rotation kit **(NM277)**.
- Check the condition of the foams area **(NM285 or NM299)**, and the carpet **(NM254)** or roll-up tracks **(NM286)**.
- Any damaged or distorted component should be replaced as quickly as possible.

### Composition :

#### 1/ 14 x 14M «MONTREAL» EVOLUTION COMPETITION EXERCISE FLOOR WITH MOUNTED & NOT MOUNTED SPRINGS CARPET VERSION (REF.: 6775D & 6775D/DE):

- Overlay carpet 14 x 14m (Ref: 6380H) -> Detailed Pack list: refer to instructions NM254.
- Set of 4 finishing bibs 14m (Ref: 6575/10): Volume 0.06 m<sup>3</sup>, Weight 9.5 kg, Dimensions 600 x 420 x 240 mm -> instructions NM299.
- Impact-absorbing foam area 14 x 14m - thickness: 56 mm (Ref: 6788B) -> Detailed Pack list: refer to instructions NM299.
- High elasticity floor 14 x 14m with springs mounted (Ref: 6785A) or springs not mounted (Ref: 6787A).
- Floor Anti-Rotation Kit - 4 adjustable cables (Ref: 6529/00) -> Detailed Pack list: refer to instructions NM277 (included in floor).

#### 2/ 14 x 14M «MONTREAL» EVOLUTION COMPETITION EXERCISE FLOOR WITH MOUNTED & NOT MOUNTED SPRINGS ROLL-UP TRACKS VERSION (REF.: 6776C & 6776C/DE):

- Gymnastics Area 14x14m th. : 3.8cm «Montreal» evol. Comp. Exercise floor M'20 (Ref.: 6776/00) -> Detailed Pack list: refer to instructions NM286.
- Set of 4 finishing bibs 14 m (Ref: 6575/10): Volume 0.06 m<sup>3</sup>, Weight 9.5 kg, Dimensions 600 x 420 x 240 mm -> instructions NM286.
- Foam underlay 14x14m thickness: 24mm Exercise floor M'20 (Ref.: 6776/10) -> Detailed Pack list: refer to instructions NM285.
- High elasticity floor 14 x 14 m with springs mounted (Ref: 6785A) or springs not mounted (Ref: 6787A).
- Floor Anti-Rotation Kit - 4 adjustable cables (Ref: 6529/00) -> Detailed Pack list: refer to instructions NM277 (included in floor).

### Pack list:

PACKAGES REF.	6529/00 Floor ARK Ex. Floor M'12	6785/80 Pallet 21 panels + 7 edges	6785/90 Pallet 19 panels + 2 corners	6585/19 Set 12 profiles White Length 30 cm	6785/15 Set 8 prof. White Length 1.3 m	6785/16 Set 30 prof. Grey Length 1.4 m	6785/17 Set 20 prof. White Length 1,8m	6785/18 Set 29 prof. Grey Length 1,9m	6785/60 Pack 66 plates White/Grey	6785/70 Pack 34 plates White	6785/100 Pack 5 springs + fixings	Nber of pack.
<b>6785A</b> High elasticity floor 14 x 14 m springs mounted	1	1	2	1	1	2	1	2	1	1	1	14
<b>VOLUME (m<sup>3</sup>)</b>	0.013	6.5	5.5	0.002	0.01	0.03	0.02	0.03	0.03	0.03	0.005	X
<b>WEIGHT (KG)</b>	4.2	836	758	2	4	15	15	22	3.64	2	1.2	
<b>SIZE (MM)</b>	310x210x200	2020x1510x2130	2020x1510x1820	310x150x50	1300x170x50	1400x170x110	1800x170x80	1900x170x80	410x320x230	400x310x230	200x160x150	

PACKAGES REF.	6529/00 Floor ARK Ex. Floor M'12	6787/40 Pallet 32 panels + edges	6787/50 Pallet 27 panels + 4 corners	6585/19 Set 12 prof White Len- gth 30 cm	6785/15 Set 8 prof. White Length 1,3m	6785/16 Set 30 prof. Grey Length 1.4 m	6785/17 Set 20 prof White Len- gth 1,8m	6785/18 Set 29 prof. Grey Length 1,9m	6785/60 Pack 66 plates White/Grey	6785/70 Pack 34 plates White	6787/20 Pack 113 springs only	6787/30 Pack 1356 lower supports	6785/100 Pack 5 springs + fixings	Nber of pack
<b>6787A</b> High elasticity floor 14 x 14 m springs not mounted	1	1	1	1	1	2	1	2	1	1	24	2	1	39
<b>VOLUME (m<sup>3</sup>)</b>	0.013	3.21	2.87	0.002	0.01	0.03	0.02	0.03	0.03	0.03	0.05	0.21	0.005	X
<b>WEIGHT (KG)</b>	4.2	982	909	2	4	15	15	22	3.64	2	20.2	20	1.2	
<b>SIZE (MM)</b>	310x210x200	2030x1520x1040	2030x1520x930	310x150x50	1300x170x50	1400x170x110	1800x170x80	1900x170x80	410x320x230	400x310x230	360x360x360	1300x600x270	200x160x150	

## I. Assembling the floor not mounted springs (Ref.: 6787A) of exercise floors Refs.: 6775D/DE & 6776C/DE :

Figures 1 & 2 - Clipping of springs and lower supports under floor panels

- Align vertically: the lower support (1), the spring only (2) and the upper support (3) screwed to the floor panels (p).
- Press hard on the lower support (1) to solidarize the elements simultaneously.
- The two «clacks» ensure that the three elements are correctly connected.

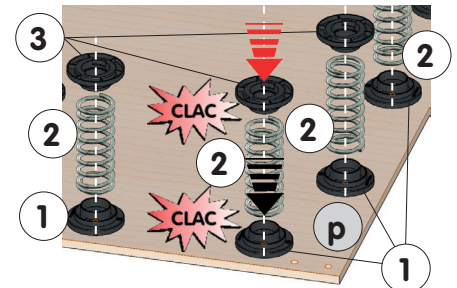
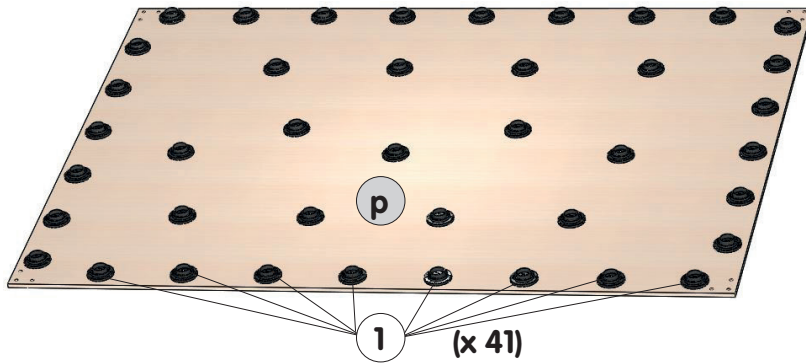

## II. Assembling the floor: (2 minimum).



**IMPORTANT:** CHECK THAT THE PACKAGING TUBES (†) OF THE PANELS (REF.: 6785A) ARE COMPLETELY REMOVED DURING ASSEMBLY.

STORE THEM FOR FUTURE STORAGE AND/OR TRANSPORT.

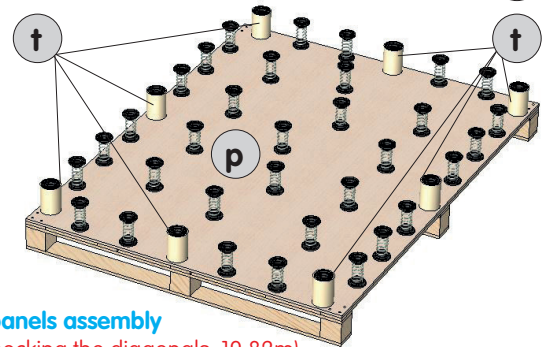
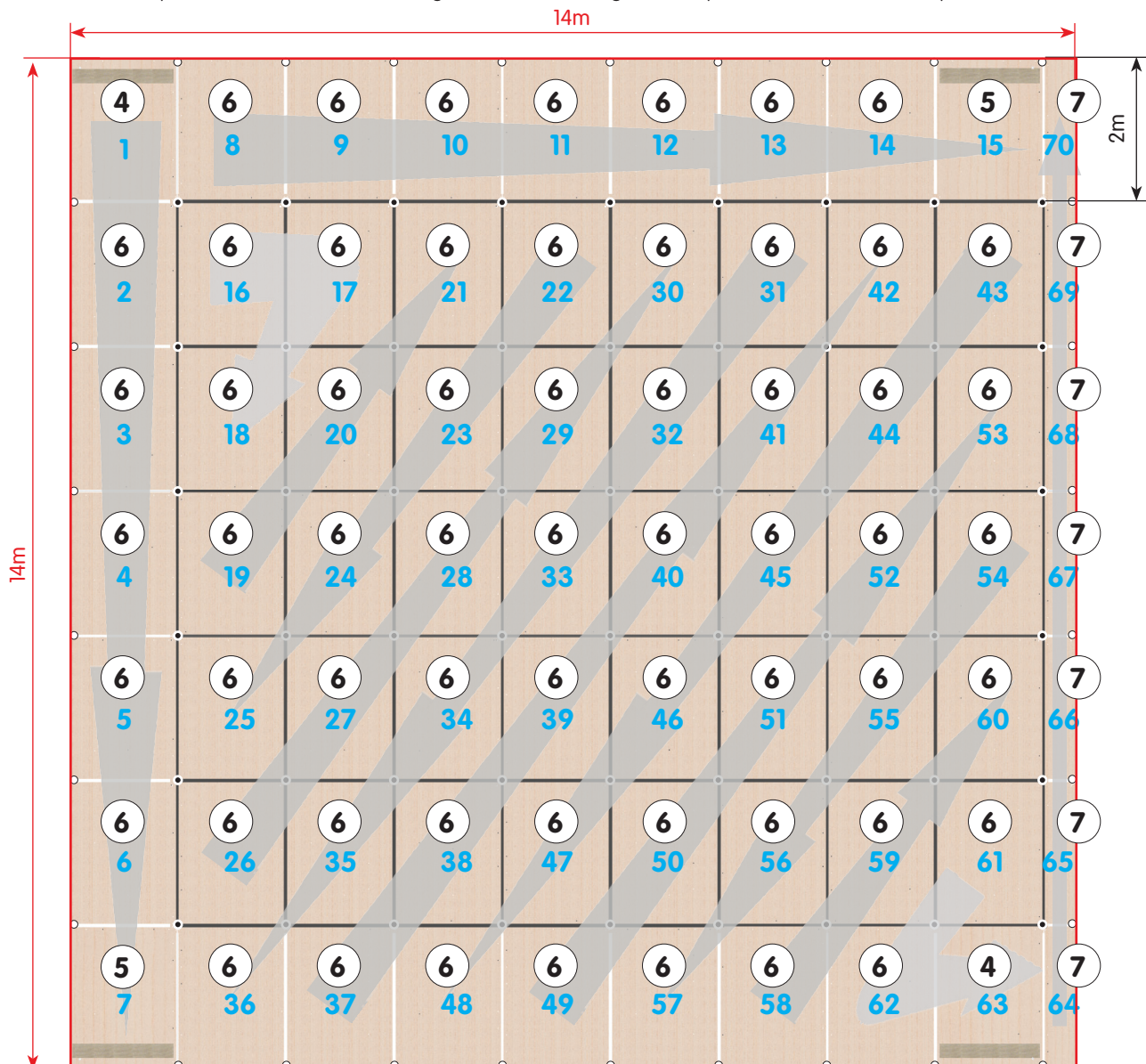

Figure 3 - Arrangement and order of the panels assembly

- On the ground, mark the overall dimensions of the floor: a 14 x 14 m square (Checking the diagonals: 19.82m)
- Assemble the 63 panels (4), (5) & (6) and the edges (7): start with 1 right corner panel (4), then follow the specified order (Blue N°)



**Figures 4, 5, 6, 7 & details - Orientation of the 4 corner panels**

**! ATTENTION, THESE 4 PANELS (4) AND (5) ARE EQUIPPED WITH:**

- Hook-and-loop strips (m) of the foam ARK, to be placed on the periphery of the floor
- And guying plates (h), provided for the hooking of the cables (c) of the floor ARK, to be orientated towards the interior of the floor.

**Right corner panel - Top & Bottom Views**

**Left corner panel - Bottom & Top Views**

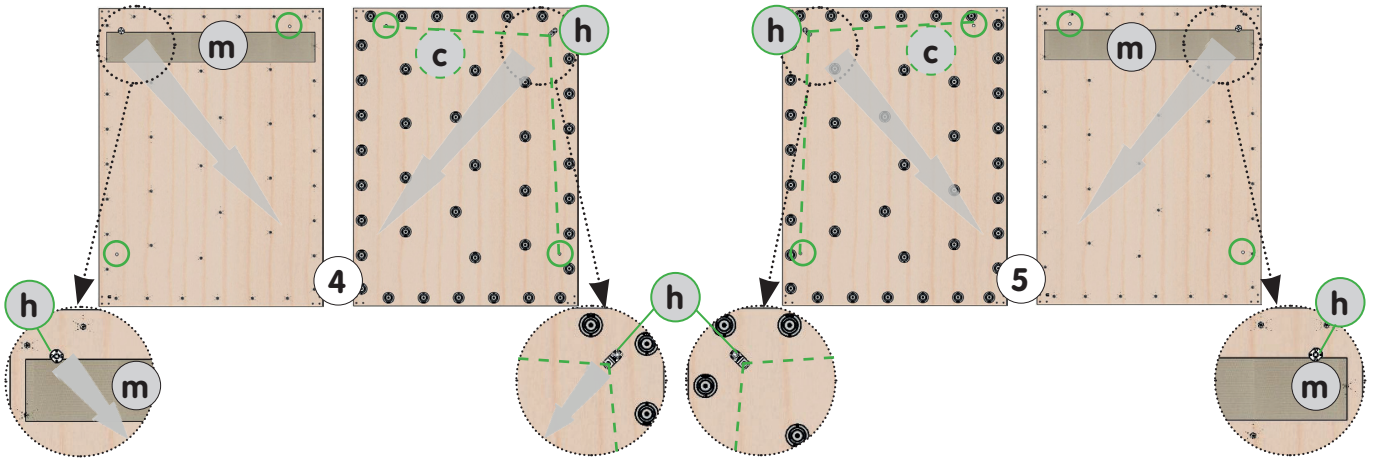

**Figure 8 - Distribution of floor panels and connecting parts**

- Assemble the white profiles (10), (11) & (12) and the white locking plates (14) on the periphery of the floor (Connection 2 panels).
- Assemble the grey profiles (8) & (9) and the white & grey locking plates (13) on the central part (Connection between 4 panels).

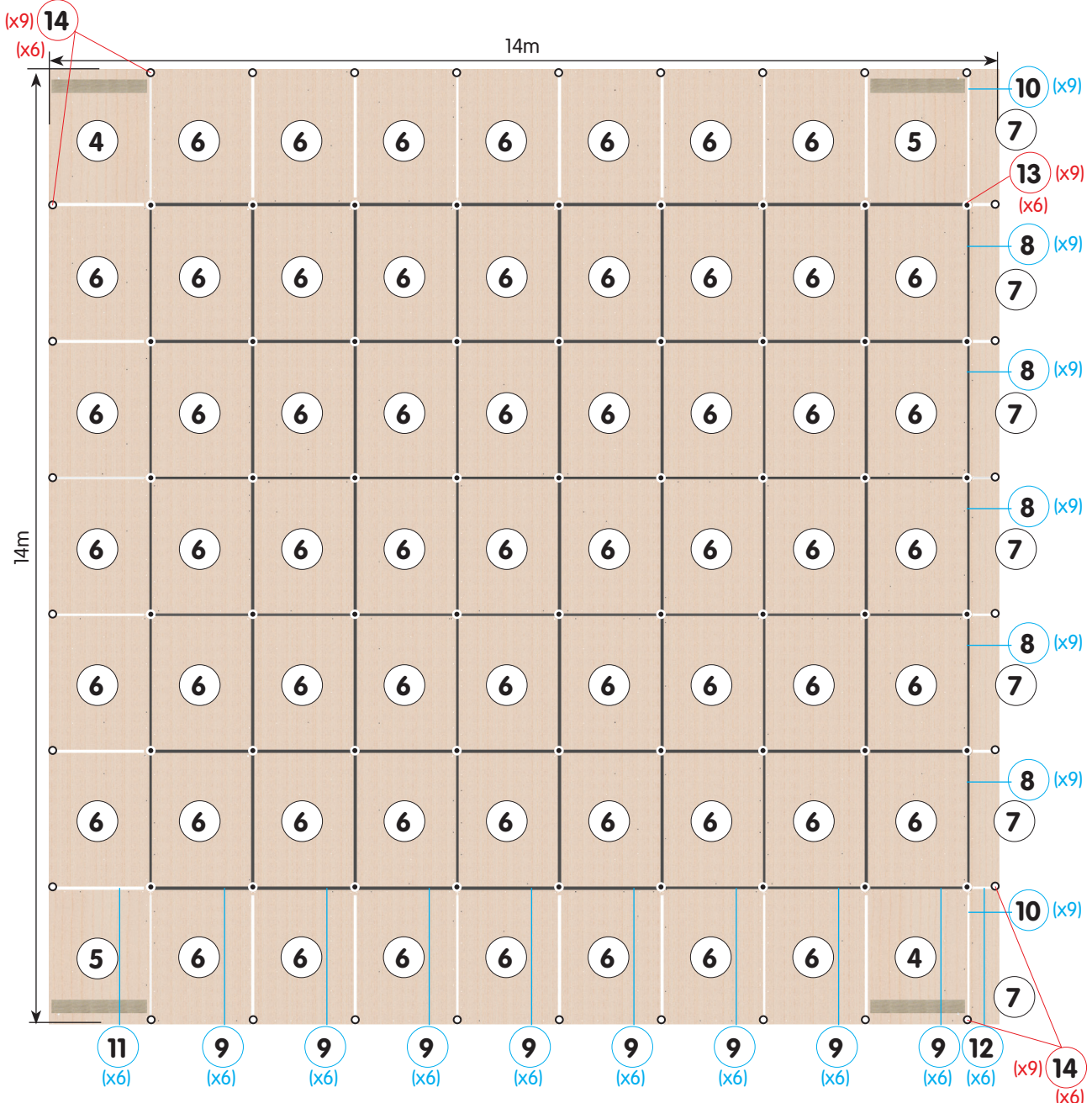

**Figure 9 & details - Installation of the connecting parts**

- Mount the locking plates (13) & (14) and the profiles (8), (9), (10), (11) & (12) as the panels are assembled.
- Center the profiles on each side of the floor panels (4), (5) & (6).
- Lock the plates (13) & (14) ✓.

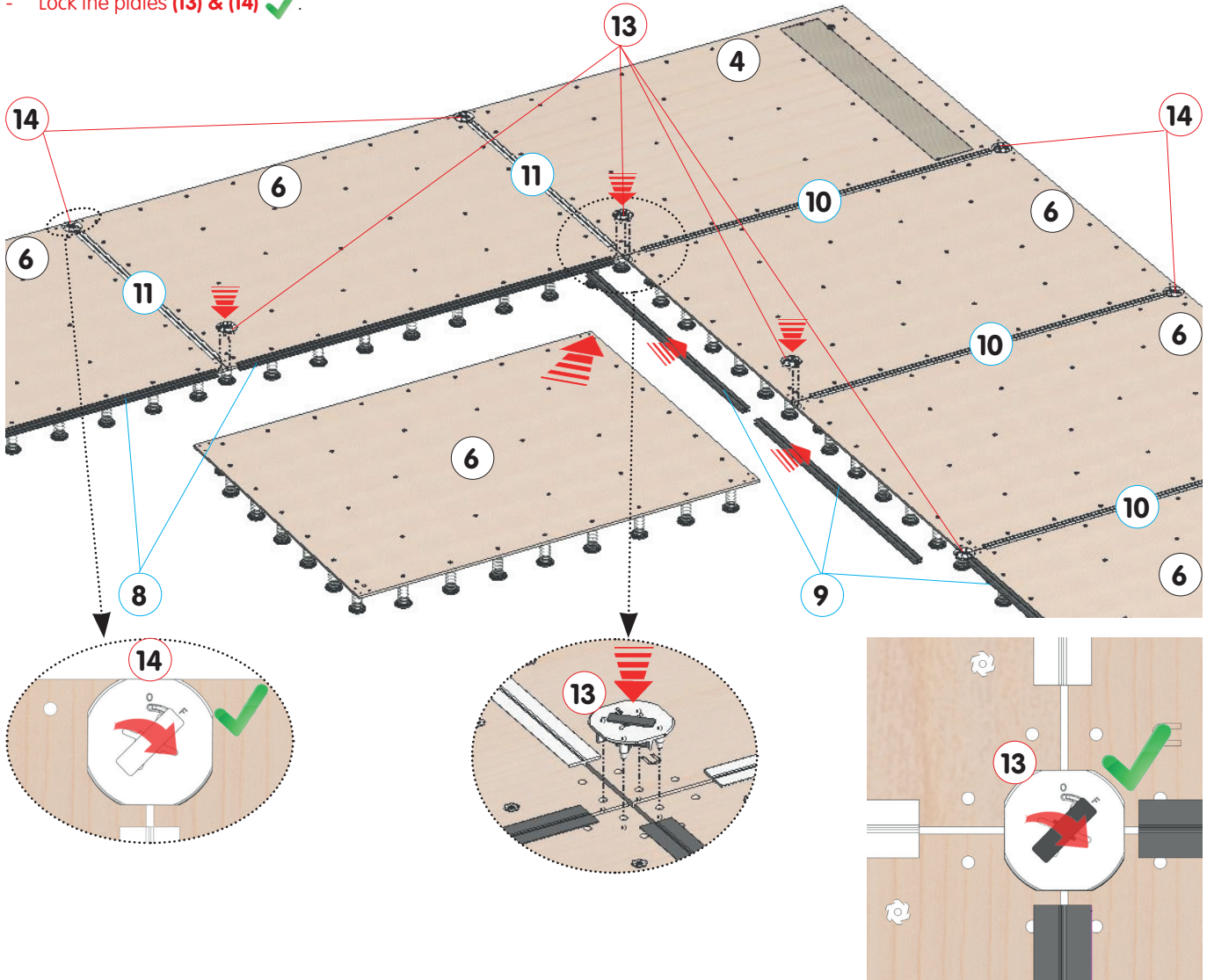

**Figure 10 - Installation of the edge panels**

- Install the 4 cables of the Floor Anti-Rotation Kit (15) according to instructions NM277.
- Finish by assembling the 7 floor edge panels (7).
- Lock the plates (13) & (14) ✓.

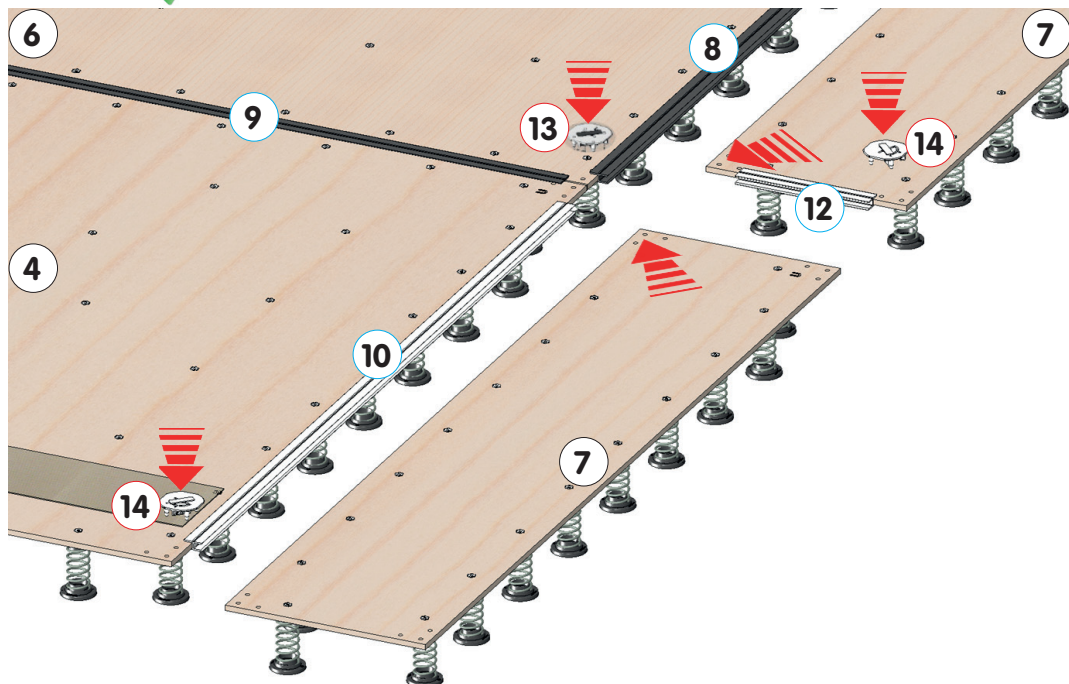

### III. Assembling the impact-absorbing foam area:

- Exercise floor Refs.: 6775D - 6775D/DE -> Foam area 14 x 14m - th.: 56mm (Ref.: 6788B) : refer to instructions NM299.
- Exercise floor Refs.: 6776C - 6776C/DE -> Foam underlay 14x14m th. : 24mm (Ref.: 6776/10) : refer to instructions NM285.

### IV. Assembling the overlay carpet or roll-up tracks evolution area:

- Exercise floor Refs.: 6775D - 6775D/DE -> Carpet 14 x 14m (Ref.: 6380H) : refer to instructions NM254.
- Exercise floor Refs.: 6776C - 6776C/DE -> Roll-up tracks evolution area 14x14mth : 3.8cm (Ref.: 6776/00) : refer to instructions NM286.

### V. Disassembling and storing the floor: (👤👤 minimum).

Figure 11 & details - Disassembling the floor

- Unlock the plates (13) & (14) ✓
- Dislodge the locking plates (13) & (14) and remove the profiles (8), (9), (10), (11) & (12).
- Dismantle the floor panels (4), (5), (6) & (7) as you go.

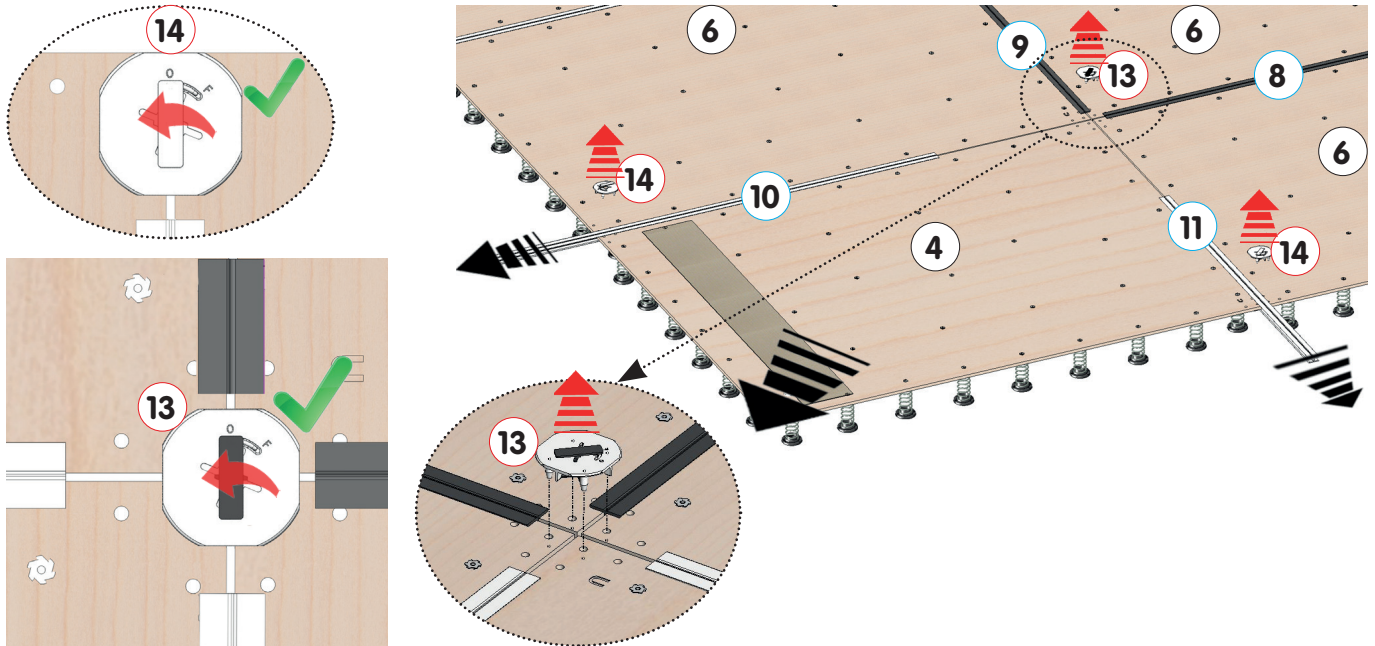

Figures 12, 13, 14 & 15 - Frequent storage for short periods

- Store floor panels (4), (5), (6) & (7) well vertically, nested 2 to 2 in each other.

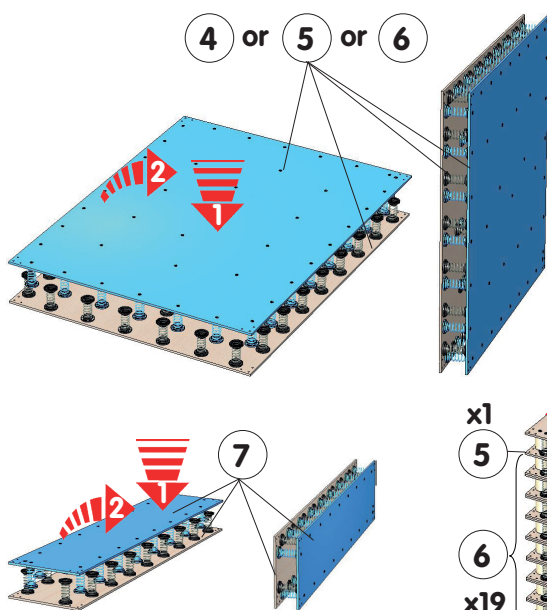

Figures 16, 17 & 18 - Prolonged storage

- It is imperative to stack the floor panels (4), (5), (6) & (7) horizontally, nested 2 to 2 in each other.
- Use the original cardboard tubes (t) between the panels: 8 for the plates 2 x 1.50m, and 4 for the edges.

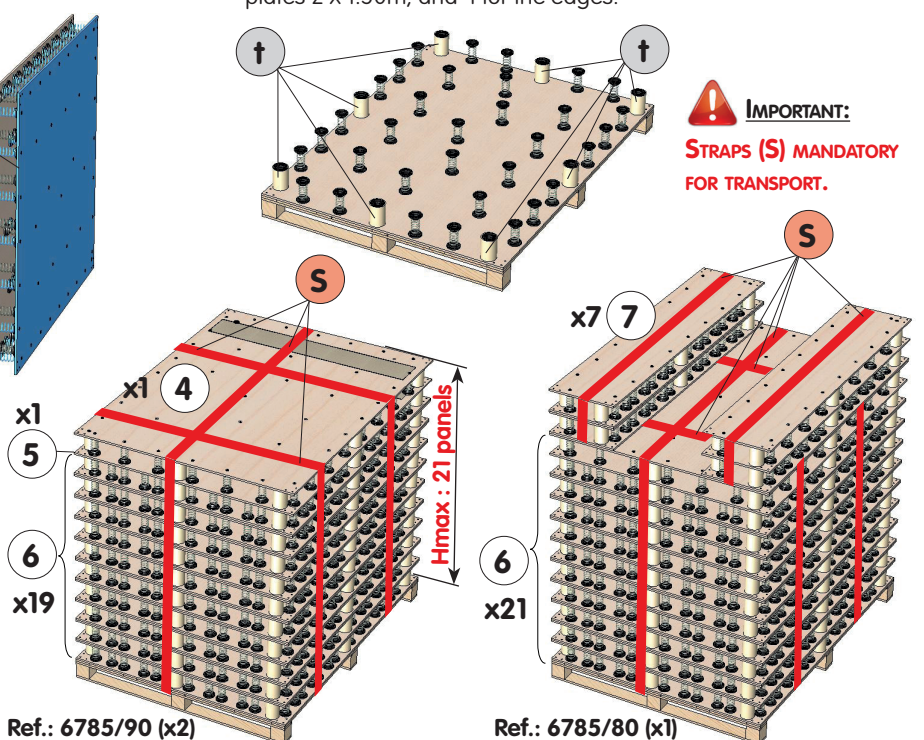

**IMPORTANT:**  
STRAPS (S) MANDATORY  
FOR TRANSPORT.

«MS» : Mounted Springs - «NMS» : Not Mounted Springs

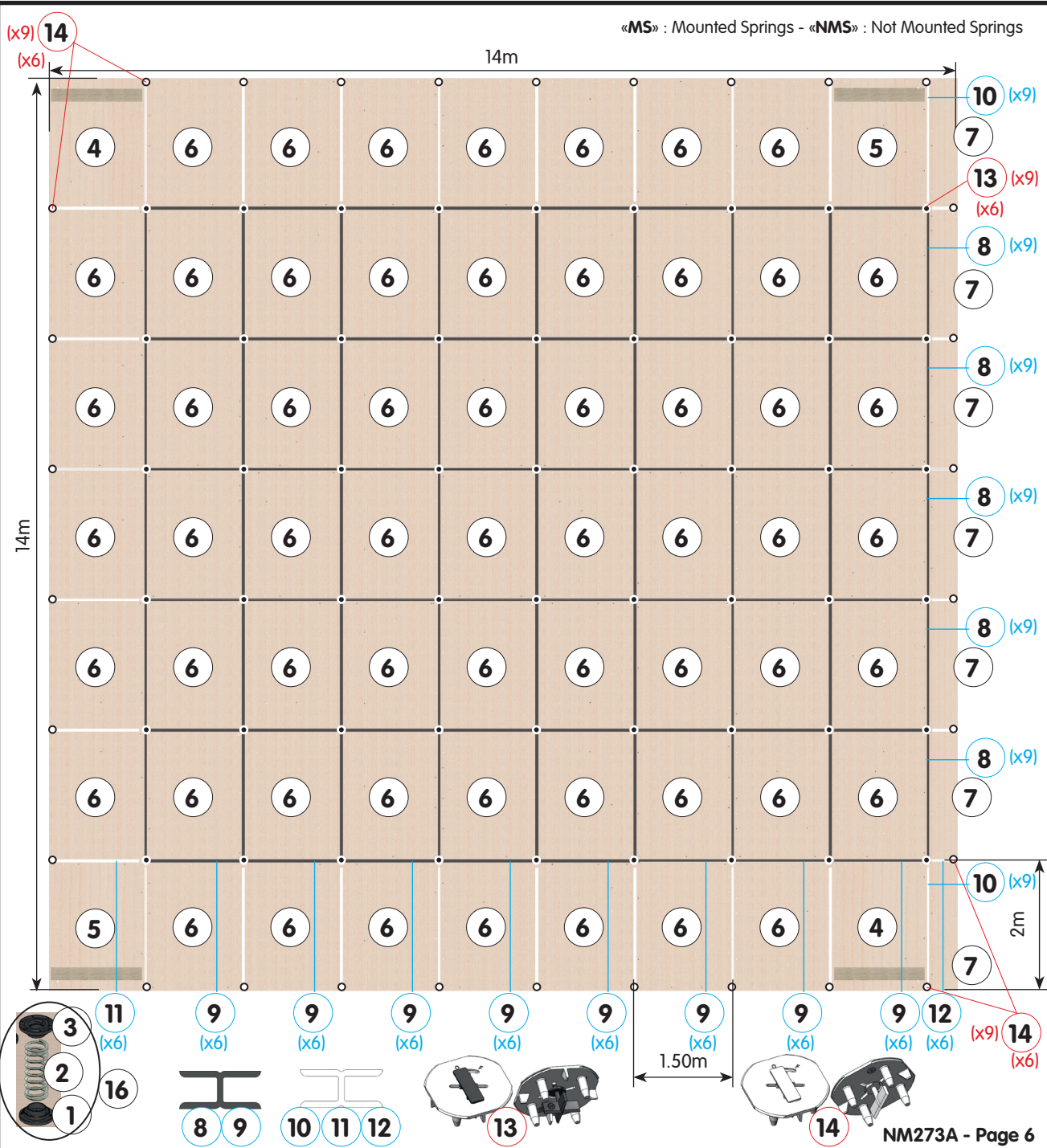

26	-	-	-	-
25	-	-	-	-
24	-	-	-	-
23	-	-	-	-
22	-	-	-	-
21	-	-	-	-
20	-	-	-	-
19	-	-	-	-
18	-	-	-	-
17	-	Set of 280 cardboard tubes / storage	6785/50	H. 13cm
16	1	Set of 5 mounted springs + fixings	6785/100	H. 13cm
15	1	Floor Anti-Rotation Kit - 4 cables	6529D	Complete - NM277
14	30	2 ribs locking plate + Lock White	6785/73	Unit - periphery
13	54	4 ribs locking plate + Lock Grey	6785/63	Unit - central part
12	6	White connecting profile Length 30cm	659/09	Unit - periphery
11	6	White connecting profile Length 1.30m	659/06	Unit - periphery
10	18	White connecting profile Length 1.80m	659/05	Unit - periphery
9	48	Grey connecting profile Length 1.40m	6785/05	Unit - central part
8	45	Grey connecting profile Length 1.90m	6785/06	Unit - central part
7'	7	2 x 0.45m Edge panel NMS	6787/44	6775D/DE - 6776D/DE
7	7	2 x 0.45m Edge panel MS	6785/84	6775D - 6776D
6'	59	2 x 1.50m Central panel NMS	6787/41	6775D/DE - 6776D/DE
6	59	2 x 1.50m Central panel MS	6785/81	6775D - 6776D
5'	2	2 x 1.50m Left corner panel NMS	6787/42	6775D/DE - 6776D/DE
5	2	2 x 1.50m Left corner panel MS	6785/82	6775D - 6776D
4'	2	2 x 1.50m Right corner panel NMS	6787/43	6775D/DE - 6776D/DE
4	2	2 x 1.50m Right corner panel MS	6785/83	6775D - 6776D
3	2709	Spring upper support	-	6775D/DE - 6776D/DE
2	2709	Black spring only diam. 4 - H. 12.5cm	-	6775D/DE - 6776D/DE
1	2709	Spring lower support	-	6775D/DE - 6776D/DE

ITEM	QTY	DESCRIPTION	REFERENCE	REMARKS
------	-----	-------------	-----------	---------

## 14 x 14M THICKNESS 14CM SPRUNG FLOORS WITH MOUNTED & NOT MOUNTED SPRINGS «MONTREAL» EVOLUTION COMPETITION EXERCISE FLOOR M'20

To order spare parts, please provide the description, reference and delivery date of the entire apparatus.

Constantly aiming to improve our products, we reserve the right to make changes to the equipment and dimensions without further discussion.  
This document is the propriety of Gymnova, it is confidential and shall not be reproduced.

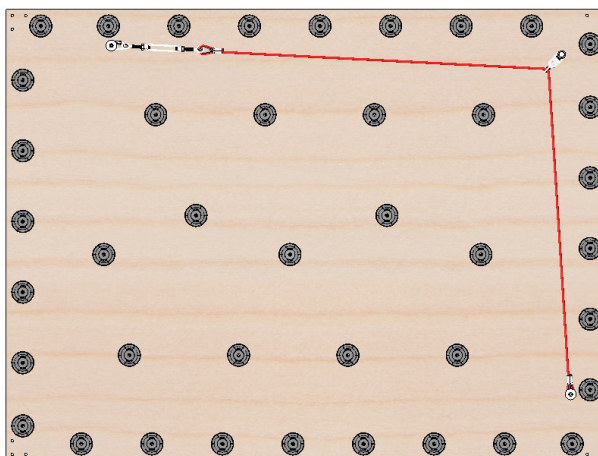
**STOPPER CABLES AND ANTI-ROTATION KITS FOR  
14 x 14 M & 13 x 13 M FLOORS OF SPRUNG  
EXERCISE FLOORS M'16.****6529/00  
6529D**KEEP THIS  
DOCUMENT**Warning:**

This equipment should be installed by a qualified individual. The attachments that are provided with these kits may only be used if the support complies with specification **CC78**. Using this equipment for purposes other than those originally intended is prohibited.

**Recommendations:**

As set out in French Standard NF S52-400 the following is recommended:

- keep these instructions for subsequent reference (inspection, maintenance, etc.).
- periodically carry out predictive maintenance.
- depending on how often it is used, have the equipment serviced yearly or every few years.

**Pack list:**

1 Pack (Ref: **6529/00**) -> Set of 4 adjustable stopper cables + floor attachments:

Weight: 4.5 kg      Dimensions: 310 x 210 x 200 mm      Volume: 0.01 m<sup>3</sup>

1 Pack (Ref: **6529D**) -> Set of 4 complete adjustable stopper cables:

Weight: 5.5 kg      Dimensions: 300 x 210 x 200 mm      Volume: 0.01 m<sup>3</sup>

**Uses of stopper cables:**

These cables stop the rotation and/or translational motion of the high elasticity floors in GYMNOVA gymnastics sprung exercise floors (Ref: 6775 & 6775/DE - 6777 & 6777/DE).

**I. Assembly of Anti-Rotation Kit: minimum**

**1** Locate the 2 holes on each corner panel - Left **(1)** and Right **(2)** (symmetrical floor): position of drilled holes for Anti-Rotation Kit attachments.

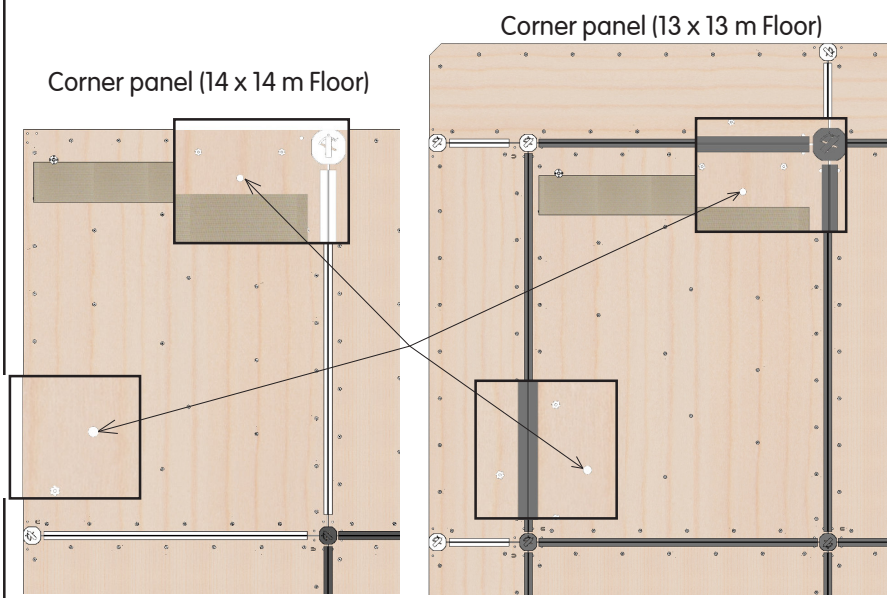

**2** Pre-drill the flooring (Ø12mm) through the holes of the panels

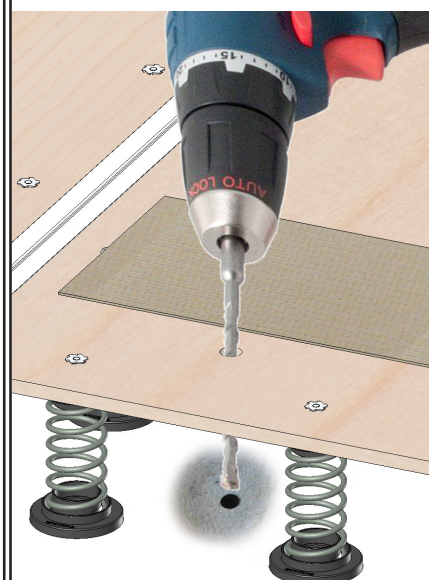

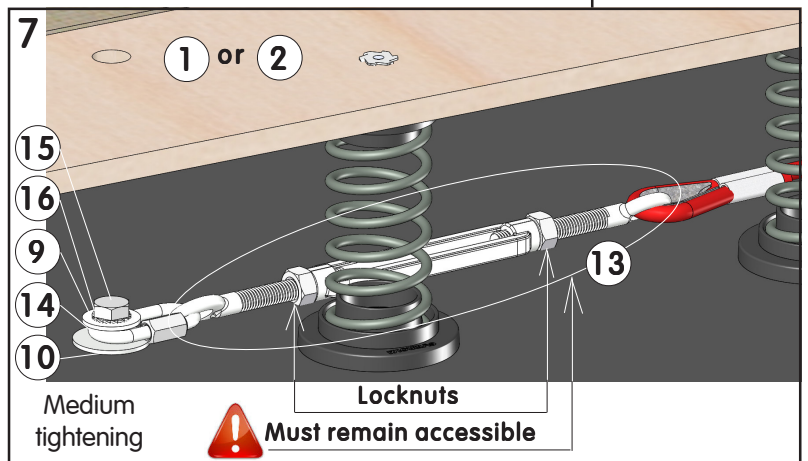
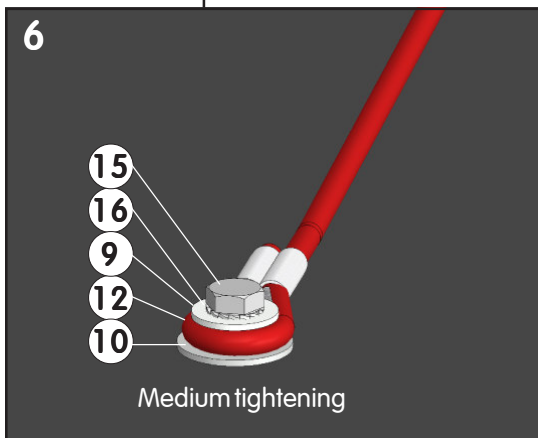
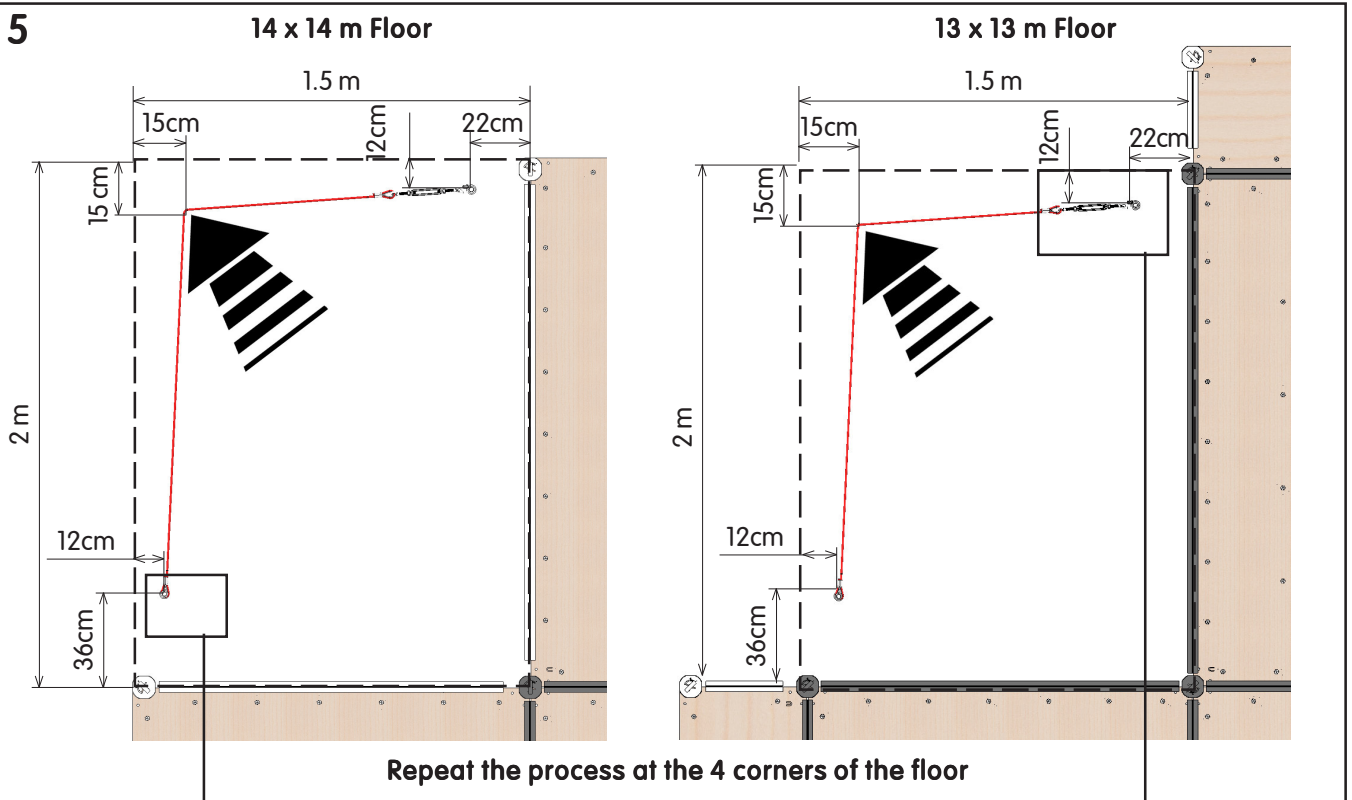
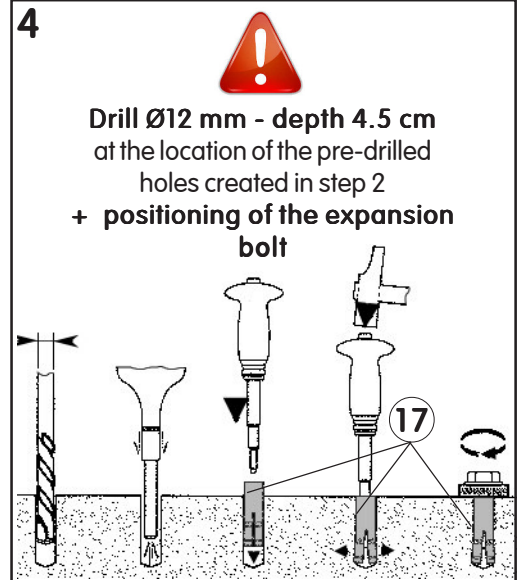
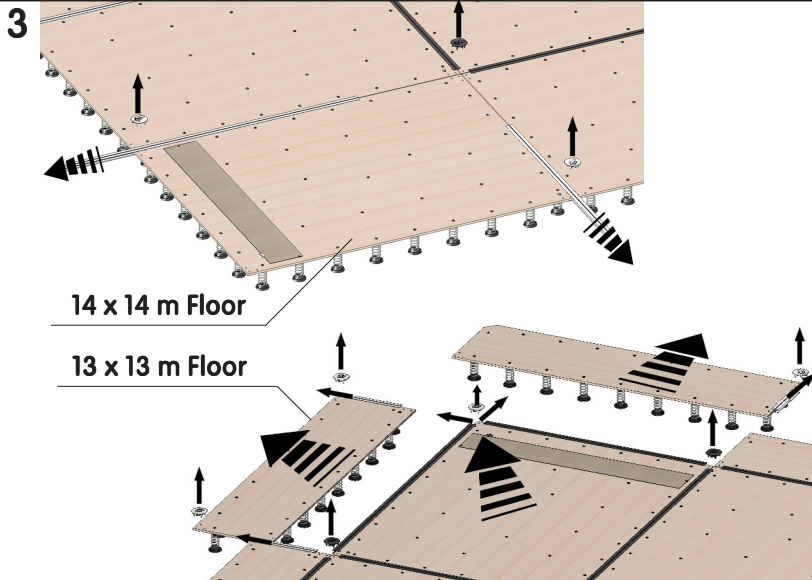



8

14 x 14 m Floor

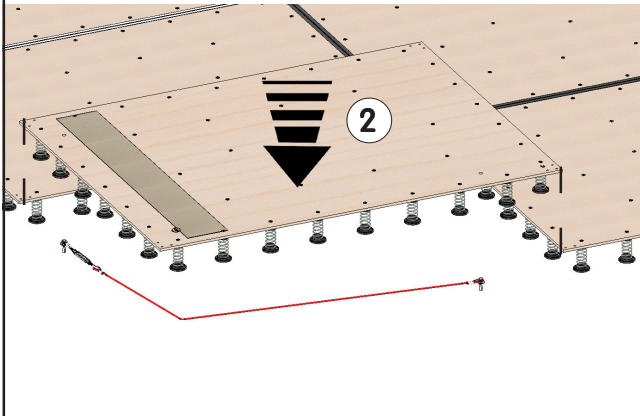

13 x 13 m Floor

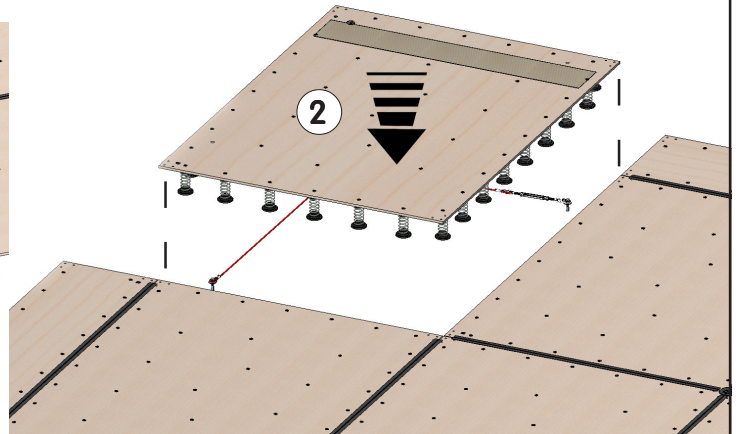

9

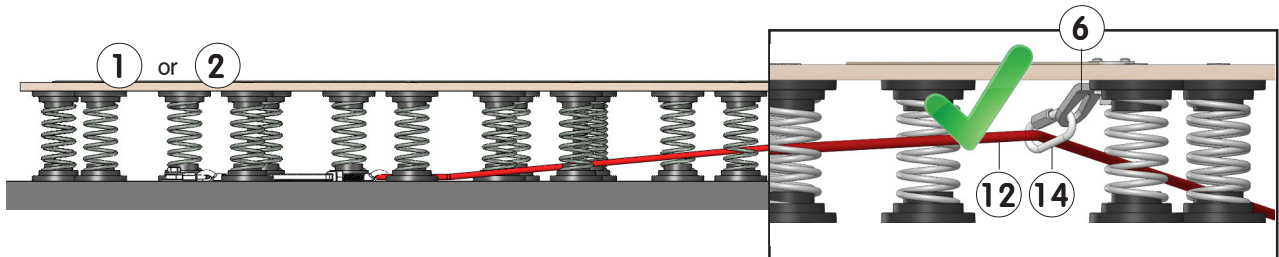

10

14 x 14 m Floor

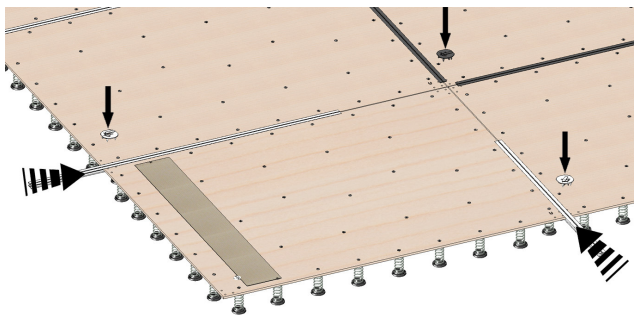

13 x 13 m Floor

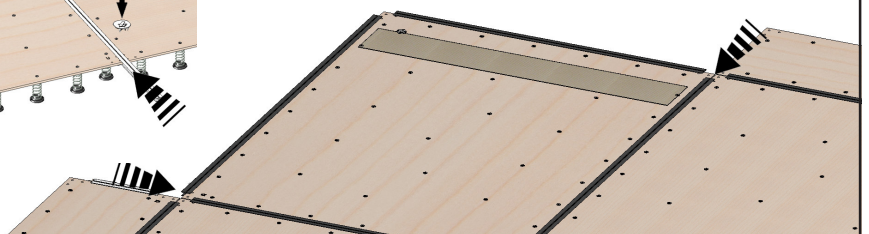

11

Screw in each tensioner (13) so that the cable (12) no longer rests on the floor. Firmly tighten the floor attachments (10, 9, 16 & 15). Hold the tensioner with a screwdriver and lock the locknuts with the spanner.

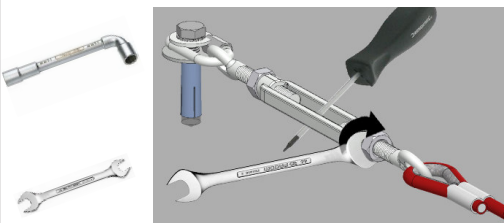

Tube spanner and open end spanner no. 16 or 17.

12

13 x 13 m Floor only

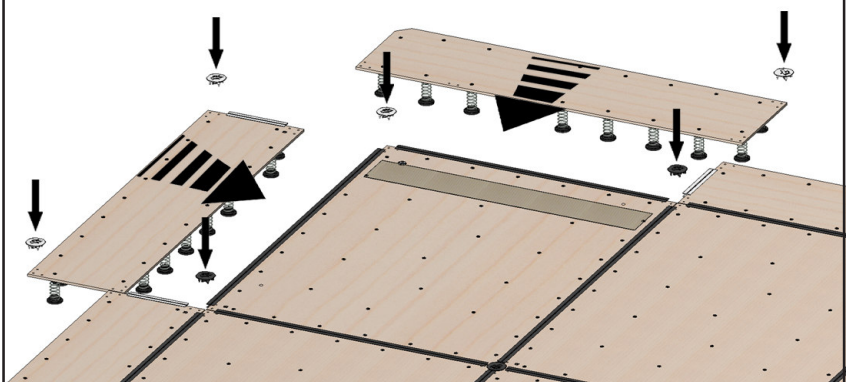

### Maintenance:

- Regular cleaning of the floor will make it easier to spot any problems (distortion, breakage or corrosion).
- Before each use, make a thorough check on the condition of the components: wear of bracing flats (6), cables (12), quick links (14) and turnbuckles (13).
- Periodically check the tensioning of cables (11), locking of tensioners (13), and closure of quick links (14).
- Check that the attachments (15) are locked and that the bolts (17) are not coming away from the flooring.

### Important:

- If a problem is found or suspected, do not use the equipment until it has been checked by a technician.
- Any damaged or distorted component should be replaced as quickly as possible.

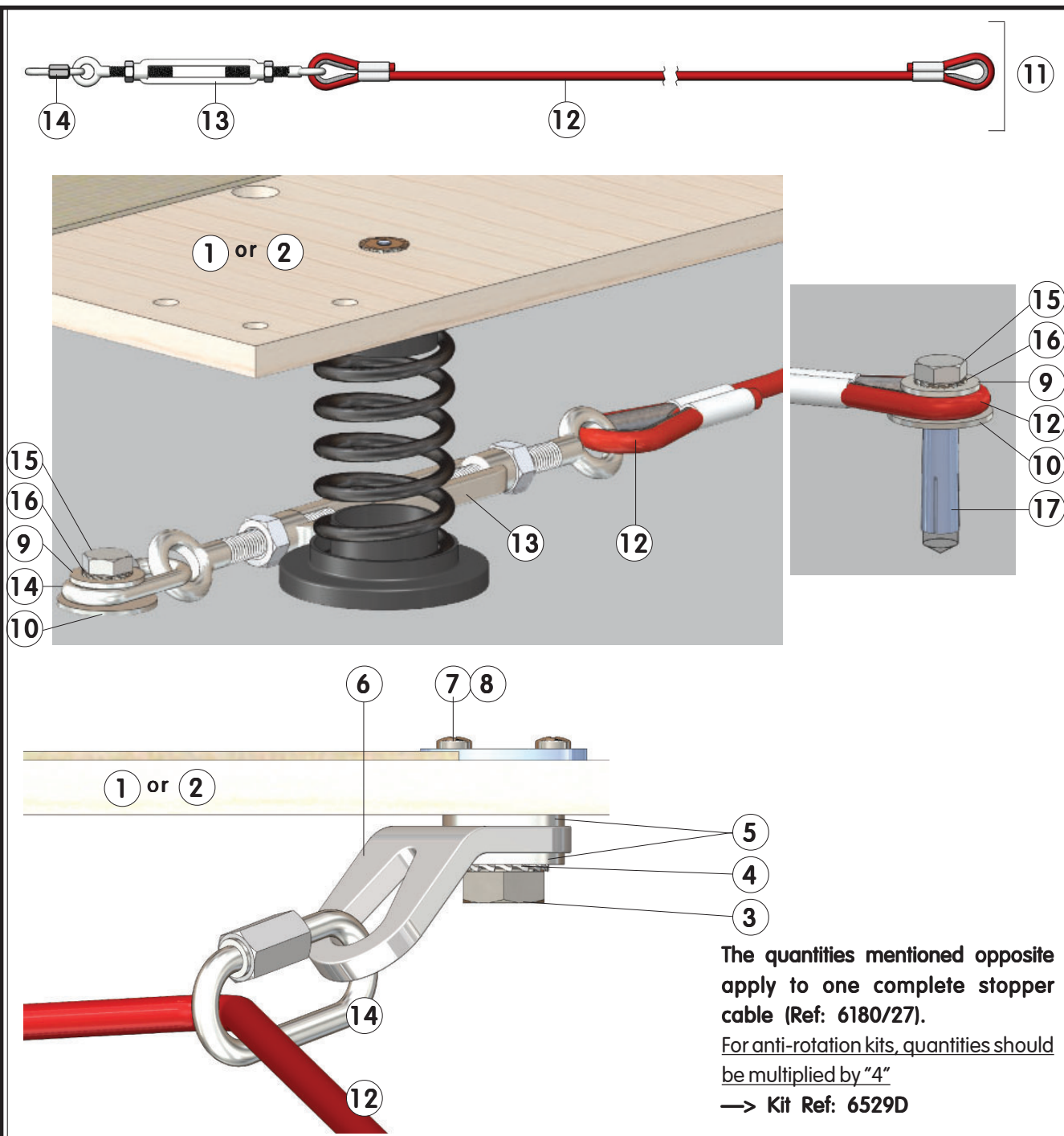

The quantities mentioned opposite apply to one complete stopper cable (Ref: 6180/27).  
 For anti-rotation kits, quantities should be multiplied by "4"  
 → Kit Ref: 6529D

To order spare parts, please provide the description, reference and delivery date of the entire apparatus.

30	-	-	-	-
29	-	-	-	-
28	-	-	-	-
27	-	-	-	-
26	-	-	-	-
25	-	-	-	-
24	-	-	-	-
23	-	-	-	-
22	-	-	-	-
21	-	-	-	-
20	-	-	-	-
19	-	-	-	-
18	-	-	-	-
17	2	M10 hammer-type exp. bolt	QCEC100000	Floor attachments
16	2	External tooth lock washer dia. 10 x 18	VREE10180Z	Floor attachments
15	2	H M10 x 30 ZP screw	VH0010030Z	Floor attachments
14	2	Quick link No. 6	QMRA00006Z	1 included in 11
13	1	M10 O/O turnbuckle	QTELE1010G	included in 11
12	1	5.5 dia. cable - length: 2.26 m	-	included in 11
11	1	Adjustable stopper cable	-	each
10	2	LL 10 x 36 flat washer	VRP010360Z	Floor attachments
9	2	L 10 x 27 flat washer	VRP010270Z	Floor attachments
8	2	Pan-head chipboard screw, dia. 4 x 16	VVBZ40016Z	included in 1 and 2
7	1	M12 screw nut	VEAV12210Z	included in 1 and 2
6	1	Bracing flat	X3120/12	included in 1 and 2
5	2	LL 14 x 36 flat washer	VRP014360Z	included in 1 and 2
4	1	External tooth lock washer dia. 12 x 20	VREE12200Z	included in 1 and 2
3	1	H M12 x 25 ZP screw	VH0012025Z	included in 1 and 2
2	-	Right corner panel 2 x 1.5 m	6785/13	-
1	-	Left corner panel 2 x 1.5 m	6785/12	-
ITEM	QTY	DESCRIPTION	REFERENCE	REMARKS

**GYMNOVA**  
 RUE GASTON DE FLOTTE  
 13012 MARSEILLE  
 Tél. : 33-(0)-4-91-87-51-20  
 Fax : 33-(0)-4-91-93-86-89

**STOPPER CABLES AND ANTI-ROTATION  
 KITS 14 x 14 M & 13 x 13 M  
 FLOORS FOR SPRUNG EXERCISE  
 FLOORS M'16**

BY: M. CHARBONNEAU DATE: 07/03/17 NM277-GB Ref.: 6529/00 - 6529D

THIS DOCUMENT IS THE PROPERTY OF GYMNOVA. IT IS CONFIDENTIAL AND SHALL NOT BE REPRODUCED WITHOUT PRIOR AUTHORIZATION